



SAMSUNG

DLP TV

Owner's Instructions

- HL-R5078W**
- HL-R5678W**
- HL-R6178W**
- HL-R7178W**

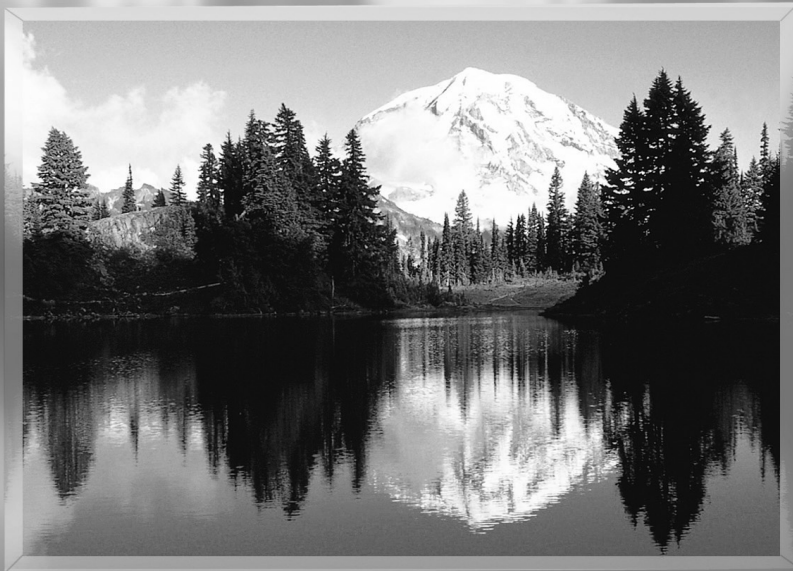

This device is a Class B digital apparatus.

Register your product at www.samsung.com/global/register

Trademark Notice

In the United States, TV GUIDE and other related marks are registered marks of Gemstar-TV Guide International, Inc. and/or one of its affiliates. In Canada, TV GUIDE is a registered mark of Transcontinental Inc., and is used under license by Gemstar-TV Guide International, Inc.

Aux États Unis TV GUIDE et d'autres marques relatives sont des marques déposées de Gemstar-TV Guide International, Inc. et/ou d'une de ses sociétés affiliées. Au Canada TV GUIDE est une marque déposée de Transcontinental Inc., utilisée sous licence de Gemstar-TV Guide International, Inc.

En los Estados Unidos, TV GUIDE y otras marcas relacionadas son marcas registradas de Gemstar-TV Guide International, Inc. y/o una de sus empresas afiliadas. En Canadá, TV GUIDE es una marca registrada de Transcontinental Inc., y se utiliza bajo licencia de Gemstar-TV Guide International, Inc.

License Notice

The TV Guide On Screen system is manufactured under license from Gemstar-TV Guide International, Inc. and/or one of its affiliates.

Le système TV Guide On Screen est fabriqué sous licence de Gemstar-TV Guide International, Inc. et/ou d'une de ses sociétés affiliées.

El sistema TV Guide On Screen se fabrica bajo licencia de Gemstar-TV Guide International, Inc. y/o una de sus empresas afiliadas.

A Guide to Digital TV

- **What is Digital Television?**

Digital television (DTV) is a new way of transmitting high quality video and audio to your TV set. Using DTV, broadcasters can transmit high definition TV (HDTV) images, Dolby digital surround audio, and new services such as multicasting (transmitting more than one program on the same TV channel) and datacasting. Several of these services can be combined into a single digital broadcast.

Digital Television Services

- **Digital Picture Quality**

DTV programs are transmitted in two different formats. The first is Standard Definition Television (SDTV) and the second is High Definition Television (HDTV).

- **SDTV** program formats include 480-line interlaced (480i) and 480-line progressive (480p) video. 480i programs are essentially a digital version of our current analog TV programs, while the 480p format offers improved image detail over 480i. Some 480p programs are broadcast in widescreen and are comparable to progressive-scan DVD movies in image quality.

- **HDTV** program formats include 1080-line interlaced (1080i) and 720-line progressive (720p). Both HDTV formats are always broadcast in widescreen, and offer much higher picture quality than SDTV.

- **Dolby Surround Sound**

With DTV, you can listen to a variety of Dolby digital audio formats from Dolby Surround 2.0 to Dolby Digital 5.1 surround, using your home audio system. Many HDTV programs are now broadcast with DD 5.1 soundtracks.

CableCARD and Digital Cable Ready TVs

CableCARD and Digital Cable Ready TVs are the products of a new digital cable standard. This new standard is called OpenCable and it is a concerted effort to standardize the digital cable service network interface in North America. For more information, please refer to www.cablelabs.com.

Digital Cable Ready TVs are equipped with a proper digital cable tuner to receive digital cable signals from your local cable service provider. They are also designed to work with digital cable card modules (PCMCIA card modules called CableCARDS). These PCMCIA card modules or CableCARDS will be provided by your local cable service provider after a proper subscription process.

The provided CableCARD from your local cable service provider needs to be inserted into the CableCARD slot of a Digital Cable Ready TV. Please refer to page 21 for how to insert the CableCARD. A digital set-top box which used to be provided by the cable service provider is no longer needed with Digital Cable Ready TVs and CableCARDS.

When CableCARD is inserted into the slot, the TV screen will show the message that CableCARD is inserted and tries to download necessary data such as channel information or subscription information from your digital cable service provider. When you insert CableCARD for the first time, this process may take a few minutes depending on the amount of data your cable provider needs to send. During this process the digital cable service provider or CableCARD may display messages on the TV screen to help or give you further information.

Please contact your local cable provider for more information on service availability and how to acquire a CableCARD.

NOTE

- *This television receiver supports the copy protection system regulated by DTLA (Digital Transmission Licensing Administrator). It should be noted that copy protected content may not be viewable depending on your particular connections.*

Q&A

1. Is the antenna I use for existing TV reception good enough for DTV?

Over-the-air (OTA) digital TV broadcasting uses the same channels as analog TV and works well with many existing TV antennas. However, DTV broadcast channel assignments are different than analog channels. You should find out whether your local DTV broadcasts are on VHF (channels 2-13) or UHF (channels 14-69) to see if you need a different antenna.

If your DTV channels are on UHF and you already get good UHF reception, your present antenna may work fine. The same holds true for VHF DTV reception. Note that in some markets, both VHF and UHF channels are used for DTV broadcasts.

You can find out the latest DTV channel assignments for your area by browsing selected Internet web sites such as www.titantv.com, www.10000watts.com, and www.fcc.gov.

2. How difficult is it to receive DTV signals indoors?

This depends on whether your local DTV stations are running full power or not and how close your location is to the transmission tower. DTV receivers do not require as much signal as analog TV receivers to produce high-quality images and sound.

Once the DTV signal level exceeds a certain threshold at the receiver, the digital video and audio data is decoded at the same quality it was originally encoded for broadcast.

This is a big advantage for DTV over analog TV - there is no noise, ghosting, static, or scratchy audio.

3. How can I connect an antenna in my townhouse, co-operative apartment, condominium, or apartment?

The Federal Communications Commission's OTARD Rule (part of the Telecommunications Act of 1996) allows residents of condominiums, townhouse, or members of neighborhood associations to put up outside antennas for reception of broadcast TV signals as long as those antennas are not located in common areas and are no more than 12' in height.

Residents of rental units (apartments, etc.) are not covered by the OTARD rules and will have to use indoor antennas to receive DTV broadcasts. It is possible that the landlord of an apartment complex can provide broadcast DTV signals via a master TV antenna system to each apartment.

4. Can I connect my DTV set-top receiver to my cable TV service?

Cable TV systems use a different method for transmitting digital TV programs that is currently incompatible with broadcast DTV set-top receivers. So you will still need to use an outdoor or indoor antenna to receive OTA broadcast DTV programs.

The good news is that you won't have to pay a monthly or per-program charge to watch OTA DTV and HDTV programs. They're free, unlike subscription satellite TV or premium cable TV. All you need is an antenna and a DTV set-top receiver to enjoy clear, sharp widescreen images and high-quality audio.

5. I hear a Clicking sound in standby mode.

You will hear the sound if you have set both ANTENNA (Air) and Cable to "Yes" in the TV Guide On Screen™ Setup.

However, do not worry about this since the sound comes from inside your TV while it receives data for your TV Guide.

Table of Contents

Your New Wide TV	10
Viewing Position	10
List of Features	11
Accessories	11
Front Panel LED Indicators	12
Right side buttons	13
Side Panel Jacks	13
Rear Panel Jacks	14
Remote Control	15
Connections	18
Connecting VHF and UHF Antennas	18
Antennas with 75-ohm Round Leads	18
Connecting Cable TV	19
Cable without a Cable Box	19
Cable with a Cable Box that Descrambles All Channels	19
Connecting a VCR	20
Connecting a VCR to the Video or S-Video/Audio jack	20
Connecting CableCARD	21
Connecting a Camcorder	22
Connecting a DVD Player	23
Connecting to Y, PB, PR	23
Connecting to Audio and Video Jacks	23
Connecting a DTV Set-Top Box	24
Connecting to Y, PB, PR	24
Connecting to DVI (Digital Visual Interface)	24
Connecting a VCR and DTV Set-Top Box	25
Connecting to HDMI (High Definition Multimedia Interface)	25
Connecting a Digital Audio System	26
Connecting to an Analog Amplifier	26
Connecting to a Subwoofer Speaker	27
Operation	30
Turning the TV On and Off	30
Viewing the Menus and On-Screen Displays	30
Selecting a Menu Language	31
Memorizing the Channels	32
Adding and Erasing Channels	34
Changing Channels	35
Customizing Your Remote Control	36
Remote Control Codes	37
Setting the Clock	38
Setting the On/Off Timer	40
Setting the Sleep Timer	41
Viewing an External Signal Source	42
Assigning Names to External Input Mode	43
Channel Control	46
Selecting Your Favorite Channels	46
Viewing the Channel Lists	47
Labeling the Channels	49
LNA (Low Noise Amplifier)	50
Fine Tuning Analog Channels Analog	51
Checking the Digital-Signal Strength Digital	52

Picture Control.....	54
Picture Control.....	54
Changing the Picture Size.....	57
Digital Noise Reduction.....	58
Viewing the DNIe Demonstration.....	59
Setting the My Color Control Mode.....	60
Using the Color Weakness Enhancement Feature.....	62
Setting the Film Mode.....	63
Viewing Picture-In-Picture.....	64
Freezing the Picture.....	72
Setting the Blue Screen Mode.....	73
Sound Control.....	76
Sound Control.....	76
Setting the SRS TSXT.....	78
Auto Volume.....	79
Choosing a Multi-Channel Sound (MTS) track Digital	80
Choosing a Multi-Channel Sound (MTS) track Analog	81
Choosing a Digital Sound Format Digital	82
Selecting the Internal Mute.....	83
Setting the On/Off Melody.....	84
Setting up the Sub Woofer Output.....	85
Special Features.....	88
Setting the Function Help.....	88
Menu Transparency Level.....	89
Using the V-Chip.....	90
Viewing Closed Captions (On-Screen Text Messages) Analog	100
Viewing Closed Captions (On-Screen Text Messages) Digital	102
Setting the Port Selection Mode.....	104
Using the CableCARD.....	105
Using the CableCARD Setup Function.....	106
Using Game Mode.....	108
Using TV Guide On Screen™.....	109
Using the D-Net.....	112
How to connect compatible IEEE1394 Devices.....	112
Connection Options.....	114
4-Pin and 6-Pin Connectors.....	115
Selecting a D-Net device.....	116
The D-Net control panel.....	118
Operating Tips.....	120
Recording Tips.....	122
Tips on stopping recording.....	122
Troubleshooting (D-Net).....	123
PC Display.....	128
Using Your TV as a Computer (PC) Display.....	128
Adjusting the Picture Quality.....	131
Changing the Picture Position.....	132
Adjusting the Picture Quality and Position Automatically.....	133
Changing the Picture Size (PC Mode).....	134
Viewing the Current Resolution.....	135
Initializing the Picture Settings.....	136
Appendix.....	138
Replacing the Lamp.....	138
Troubleshooting.....	140
Cleaning and Maintaining Your TV.....	142
Using Your TV in Another Country.....	142
Specifications.....	142

SAMSUNG



Your New Wide TV



Your New Wide TV

Viewing Position

To optimize your viewing comfort, please follow the guidelines below for viewing distance. If viewing for an extended period of time, sit as far back from the screen as possible.

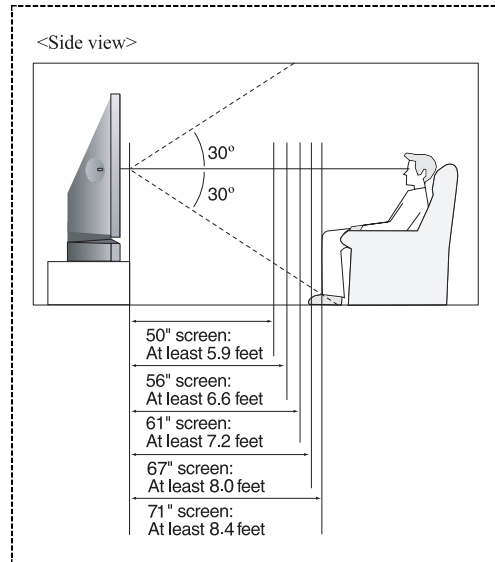
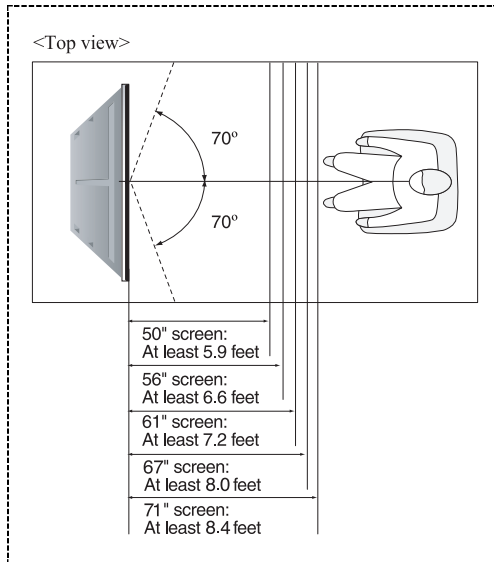

When installing the product, make sure to keep it away from the wall (more than 10cm/4 inches) for ventilation purposes.

- Poor ventilation may cause an increase in the internal temperature of the product, resulting in a shortened component life and degraded performance.

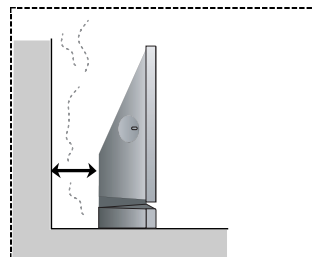

List of Features

Your TV is designed and engineered using the latest technology. It is a full-featured, high-performance unit that exceeds industry standards. In addition, it has these special features:

- Easy-to-operate remote control
- Easy-to-use on-screen menu system you can access from the front panel or remote control
- Automatic timer to turn the TV on and off at any time you choose
- Adjustable picture and sound settings and the ability to memorize your favorite settings
- Automatic channel tuning for up to 181 channels
- A special filter to reduce or eliminate reception problems
- Fine tuning control for the sharpest picture possible
- A built-in multi-channel sound decoder for stereo and bilingual listening
- Built-in, dual channel speakers
- A special sleep timer
- Picture-in-Picture capability that lets you watch two channels at once
- Widescreen TV with adjustable image size
- Life-like clear images provided by DNle technology
- My Color Control Mode for corresponding with your color preference
- Color weakness Mode
- Digital Input (HDMI/DVI IN) jack
- Digital Audio Output (OPTICAL) jack
- AV network system (Anynet) that enables you to easily control Samsung audio-video(AV) devices from this TV.
- CableCARD slot
- D-Net (IEEE1394)
- TV Guide On Screen™

Accessories

Once you have unpacked your TV, check to make sure that you have all the parts shown here. If any piece is missing or broken, call your dealer.

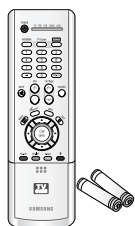

**Remote Control
(BP59-00071B)/
AAA Batteries**



Owner's Instructions



**Anynet Cable
(BN39-00518B)**



**G-LINK™ Cable
(MD96-00036A)**

Your New Wide TV

Front Panel LED Indicators

The three lights on the front panel indicate the status of your TV.

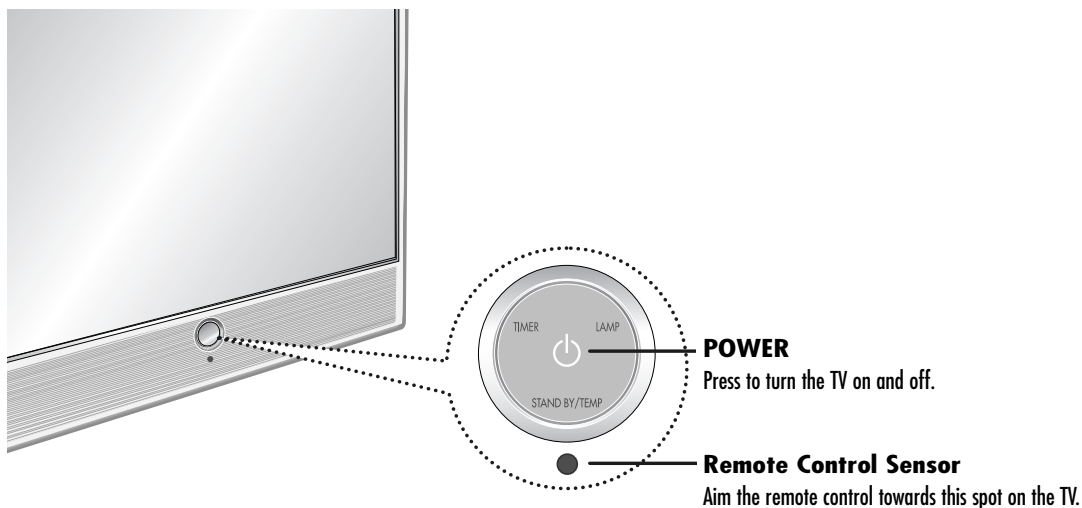

Indicator Light Key

- : Light is On
- ◐ : Light is Blinking
- : Light is Off

TIMER	LAMP	STAND BY/TEMP	Indication
○	○	●	Standby state.
○	◐	○	The picture will automatically appear in about 15 seconds.
●	◐	○	Auto Timer ON/OFF has been set and the set will automatically be turned on in about 25 seconds.
◐	○	◐	A cooling fan inside the set is not operating normally.
○	◐	◐	Lamp cover on the rear of the set is not properly shut.
○	○	◐	Check if the ventilation hole on the rear of the set is blocked, because if the inner temperature is too high, the power will shut off.
◐	◐	◐	Lamp may be defective. Please contact a certified technician.

- It takes about 30 seconds for the TV to warm up, so normal brightness may not appear immediately.
- The TV has a fan to keep the inside lamp from overheating. You'll occasionally hear it working.

Right side buttons

The buttons on the right side panel control your TV's basic features, including the on-screen menu system. To use the more advanced features, you must use the remote control.

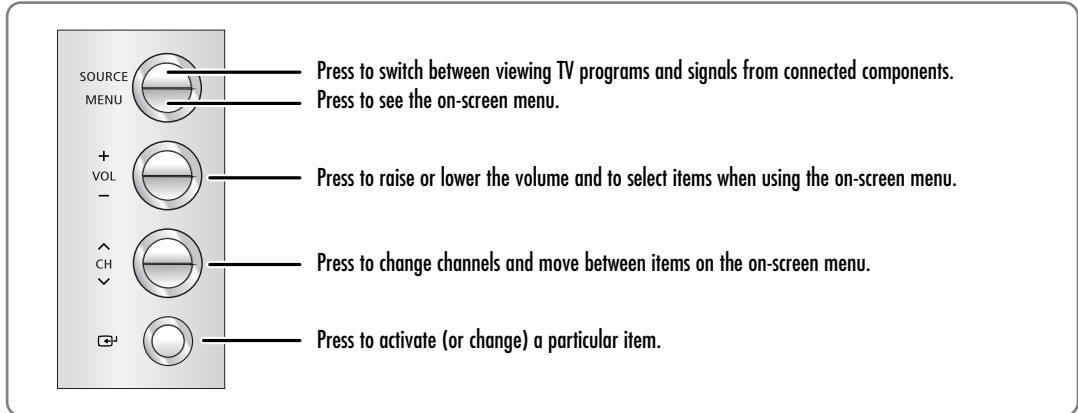

Side Panel Jacks

Use the right side panel jacks to connect a component that is used only occasionally (a camcorder or video game, for example).

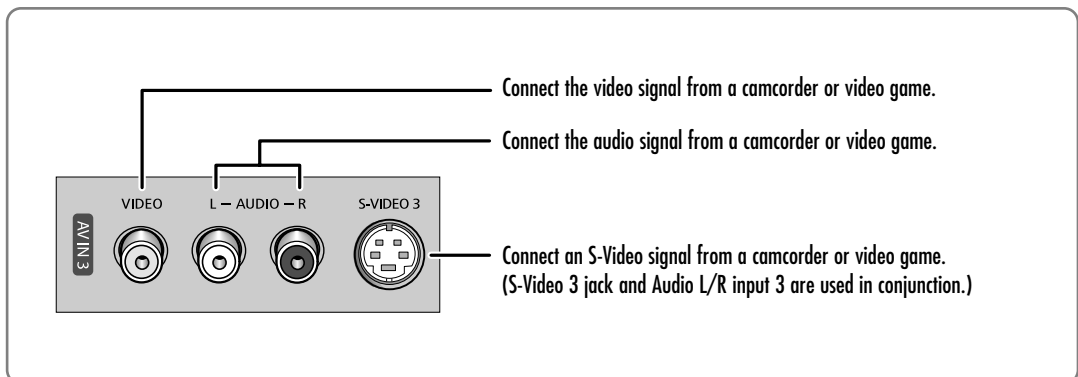

Your New Wide TV

Rear Panel Jacks

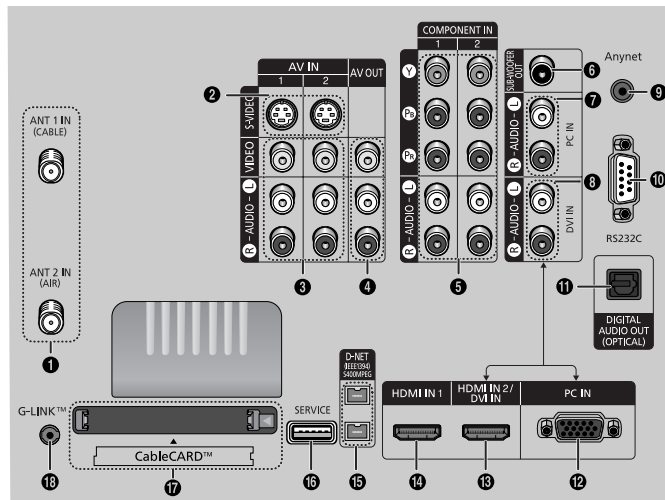

- 1 ANTENNA terminals**
Two independent cables or antennas can be connected to these terminals. Use "ANT 1 IN (CABLE)" and "ANT 2 IN (AIR)" terminals to receive a signal from VHF/UHF antennas or your cable system. (Refer to pages 18~19)
- 2 S-VIDEO INPUT jacks**
Connects an S-Video signal from an S-VHS VCR or DVD player. (Refer to pages 20 and 22)
- 3 VIDEO/AUDIO INPUT jacks**
Connect video/audio signals from external sources, such as VCR or DVD players. (Refer to page 23)
- 4 VIDEO/AUDIO OUTPUT jacks**
Sends video/audio signals from the TV to an external source, such as a VCR. These jacks are available only in RF, Video and S-Video modes.
- 5 COMPONENT1, 2 jacks (Y, PB, PR, AUDIO L/R)**
Use these jacks to connect the component video/audio signals from a DVD player or a Set-Top Box. (Refer to pages 23~24)
- 6 SUB-WOOFER OUT jack**
Connect to an active SUB-WOOFER. (Refer to page 27)
- 7 PC AUDIO INPUT jacks**
Connect these to the audio output jacks on your PC. (Refer to page 128)
- 8 HDMI 2/DVI IN (AUDIO L/R)**
Connect to the DVI audio output jack of an external device.
- 9 Anynet**
This jack is for connecting to other Samsung Anynet-enabled devices. Please refer to the Anynet Owner's Instruction.
- 10 RS232C**
Connect to a computer for reading and loading data information.
- 11 DIGITAL AUDIO OUT (OPTICAL) jack**
Connect to a Digital Audio Component. (Refer to page 26)
- 12 PC VIDEO INPUT jack**
Connect these to the video output jack on your PC.
- 13 HDMI (High Definition Multimedia Interface)/DVI INPUT jack (HDMI IN 2/DVI IN)**
Connect to the HDMI jack of a device with HDMI output. These inputs can also be used as a DVI connection with separate analog audio inputs. An optional HDMI/DVI cable will be necessary to make this connection. When using the optional HDMI/DVI adapter, the DVI analog audio inputs on your TV allow you to receive left and right audio from your DVI device. (Not compatible with PC) (Refer to pages 24~25)
- 14 HDMI (High Definition Multimedia Interface) INPUT jacks (HDMI IN 1)**
Connect to the HDMI jack of a device with HDMI output. (Not compatible with PC)
- 15 D-Net (IEEE1394) S400 MPEG**
Connect to external IEEE1394 digital products such as digital VCRs and camcorders. Two jacks are provided for this purpose, which allow for a high degree of flexibility for connecting your D-Net controlled system. (Refer to pages 112~126)
- 16 SERVICE**
This jack is for software upgrades.
- 17 CableCARD™**
Insert the CableCARD into the slot. (Refer to page 21)
- 18 G-LINK™**
Connect the IR controller cable to the G-LINK™ terminal on your TV. (Refer to page 104)

Remote Control

You can use the remote control up to about 23 feet from the TV. When using the remote control, always point it directly at the TV. You can also use your remote control to operate your VCR, Cable box, DVD player and some Samsung Set-top boxes. See pages 36~37 for details.

- 1. POWER**
Turns the TV on and off.
- 2. TV Guide**
Press to display the TV Guide On Screen™ Interactive Program Guide (IPG). (Refer to the TV Guide On Screen™ manual and TV Guide On Screen™ Quick Setup Sheet for further information on G-LINK™.)
- 3. ANTENNA**
Press to select "AIR" or "CABLE".
- 4. CHANNEL NUMBER**
Press to directly tune to a particular channel.
- 5. -**
Press to select additional channels (digital and analog) being broadcast by the same station. For example, to select channel "54-3", press "54", then press "-" and "3".
- 6. VOL +, VOL -**
Press to increase or decrease the volume.
- 7. MUTE**
Press to mute the TV sound.
- 8. Anynet**
Runs the Anynet view functions and sets up Anynet devices.
- 9. MENU**
Displays the main on-screen menu.
- 10. CH.LIST**
Displays the channel list.
- 11. FAV.CH (Favorite Channel)**
Press to switch between your favorite channels.
- 12. MODE**
Selects a target device to be controlled by the Samsung remote control (i.e., TV, STB, VCR, CABLE, or DVD).
- 13. PRE-CH**
Tunes to the previous channel.
- 14. SOURCE**
Press to display all of the available video sources (i.e., TV, Set-Top Box, VCR, DVD, DTV, PC).
- 15. CH/PAGE ^/∨**
Press to change channels. Moves from one set of screen information to the next in the TV Guide On Screen™.
- 16. INFO**
Press to display information on the TV screen.
- 17. EXIT**
Press to exit the menu.
- 18. ▲, ▼, ◀, ▶, ENTER**
Press to select highlight up, down, left, or right. While using the on-screen menus, press ENTER to activate (or change) a particular item.
- 19. D-Net**
Runs the D-Net view function. (Refer to pages 112~126)
- 20. PIP (Picture In Picture)**
Displays the available channels in sequence. (These buttons change channels in the PIP window only.) When in the TV Guide On Screen™, mode toggles between locked and unlocked in the Video Window.
- 21. STILL**
Press to pause the current screen.
- 22. P.SIZE**
Press to change the screen size.
- 23. REC**
Records a program in the TV Guide On Screen™.
- 24. DNLe (Digital Natural Image engine)**
Activates DNLe Demo mode.
- 25. SET**
Used during set up of this remote control, so that it will work compatibly with other devices (some Samsung Set-top boxes, VCR, Cable box, DVD, etc.)
- 26. MTS (Multichannel Television Stereo)**
Press to choose Stereo, Mono or SAP (Secondary Audio Program).
- 27. PIP Controls**
CH ^/∨: Press to display the available channels in sequence. (These buttons change channels in the PIP window only.)
- 28. CAPTION**
Controls the caption decoder.
- 29. ◀◀/Day-, Day+/▶▶**
Moves forward or backwards in 24 hour increments in the Listings Grid in the TV Guide On Screen™.
- 30. VCR/DVD Controls**
Controls VCR or DVD functions: Rewind, Stop, Play/Pause, Fast Forward.
- 31. RESET**
If your remote control is not functioning properly, take out the batteries and press the reset button for about 2~3 seconds. Re-insert the batteries and try using the remote control again.

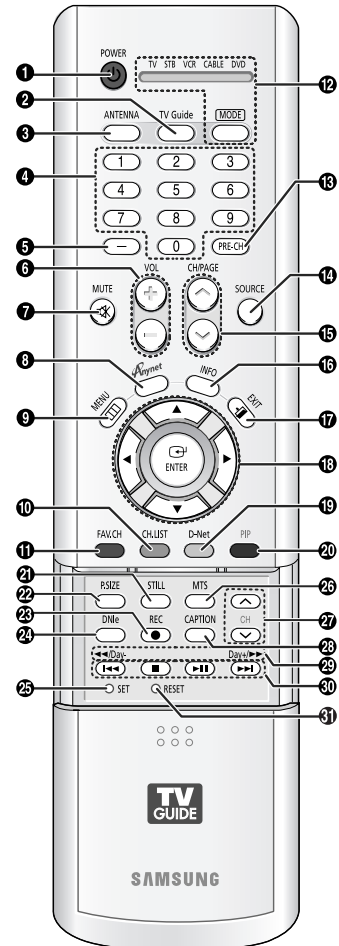

NOTE

- If you are using a cable box, the TV Guide On Screen™ system needs to be able to change channels on your cable box to download program listings when the TV is not in use. Please connect the supplied G-LINK™ cable to the G-LINK™ jack of the TV. After you connect the G-LINK™ cable you will be able to control your cable box using the TV's remote. (Refer to the TV Guide On Screen™ Quick Setup Sheet for further information on G-LINK™.)

Your New Wide TV

Installing Batteries in the Remote Control

With normal use, the batteries in the remote control should last about a year. If you notice a performance degradation while using the remote, the batteries may need to be replaced. Make sure you replace both batteries and do not mix old and new batteries in the remote control. If you won't be using the remote control for a long time, remove the batteries and store them in a cool dry place.

- 1 Slide the back cover all the way out to open the battery compartment of the remote control.

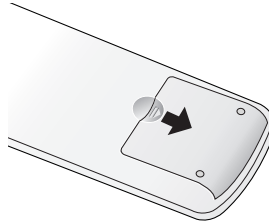

- 2 Install two AAA size batteries. Make sure to match the "+" and "-" ends of the batteries with the diagram inside the compartment.

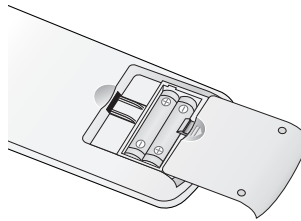

- 3 Slide the cover back into place.

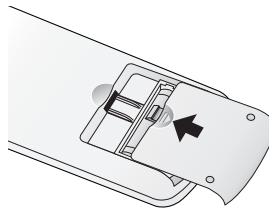

NOTE

- Do not mix battery types, i.e., alkaline and manganese.



Connections



Connections

Connecting VHF and UHF Antennas

If you do not have a cable system, you will need to connect an antenna to your TV.

Antennas with 75-ohm Round Leads

If your antenna looks like this:  it has 75-ohm round leads.

- 1 Plug the antenna lead into the ANT 2 IN (AIR) on the rear panel of your TV.

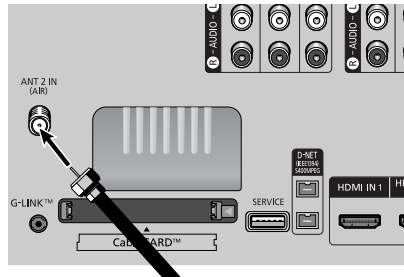

Connecting Cable TV

You can connect different cable systems to your TV, including cable without a Cable box, and cable with a Cable box that descrambles some or all channels.

Cable without a Cable Box

- 1 Plug the incoming cable into the ANT 1 IN (CABLE) on the rear panel of your TV.

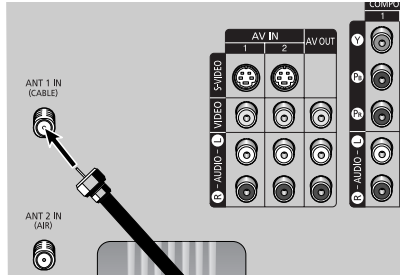

Cable with a Cable Box that Descrambles All Channels

- 1 Find the cable connected to the ANTENNA OUT terminal on your Cable box. This terminal might be labeled "ANT OUT", "VHF OUT" or simply "OUT".

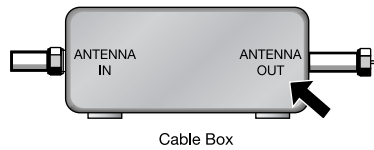

- 2 Connect the other end of the cable to the "ANT 1 IN (CABLE)" terminal on the rear panel of your TV.

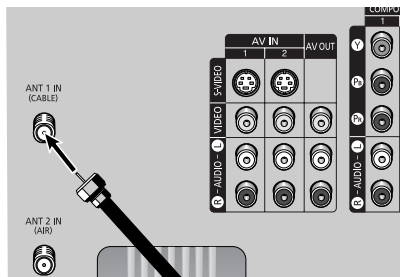

Connections

Connecting a VCR

Connecting a VCR to the Video or S-Video/Audio jack

- 1 Connect the Video/Audio cables between the VIDEO or S-VIDEO/AUDIO input jacks on the TV and VIDEO or S-VIDEO/AUDIO output jacks on the VCR.
- 2 Connect a coaxial cable between the Antenna out terminal (i.e., "OUT to TV") on the VCR and the ANT 1 IN (CABLE) on the TV.
- 3 For better playback video, connect an S-Video cable between the S-VIDEO IN jack on the TV and the S-VIDEO OUT jack on the VCR.

NOTES

- For better video, use an S-Video cable.
- Please be sure to match the color coded input terminals and cable jacks.
- When connecting the VCR and turning it on, there may be some degradation of the visual quality with noise on the TV screen. Press the TV/VCR button on the VCR remote control first to switch the VCR to the TV mode and you can tune the TV while the VCR is recording.

Alternate method

When changing the antenna connection, you do not need to press the TV/VCR button on the VCR remote control for using the recording function of the TV Guide On Screen™.

TV Rear Panel

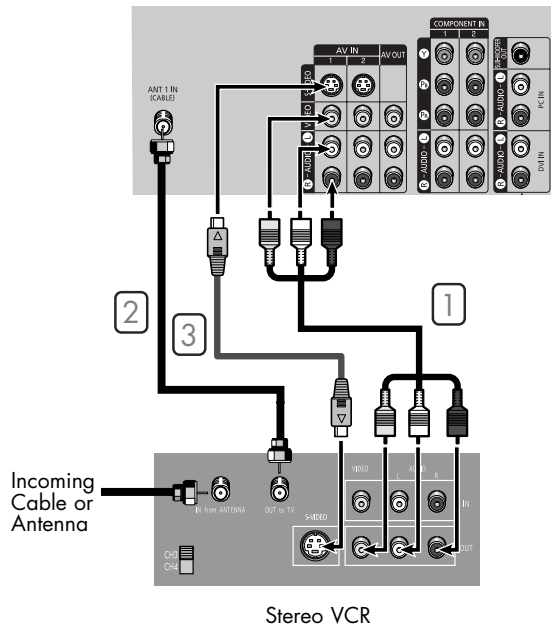

TV Rear Panel

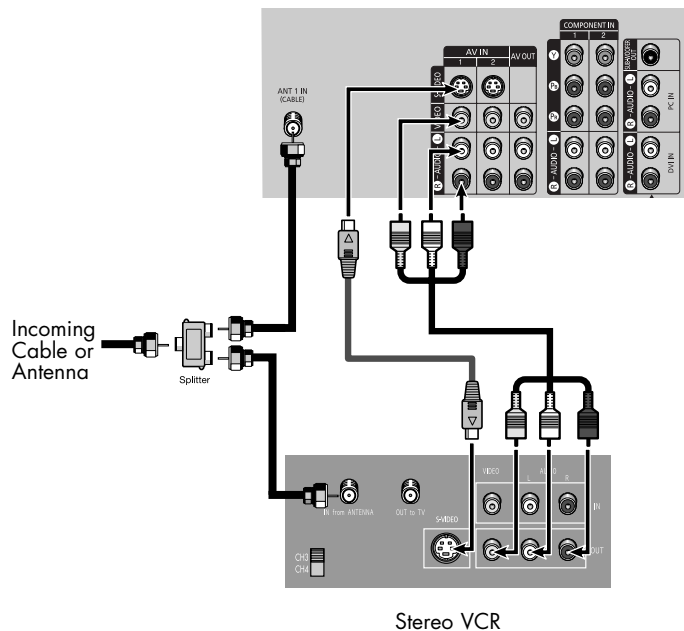

Connecting CableCARD

You must obtain a CableCARD from a local cable service provider.

1 Insert the CableCARD into the "CableCARD" slot and the message "CableCARD™ Inserted" is displayed on the screen. If the channel information does not already exist, the message "Updating Channel List" is displayed during channel information configuration.

2 When channel information configuration is finished, the message "Updating Completed" is displayed. It indicates that the channel list is now updated.

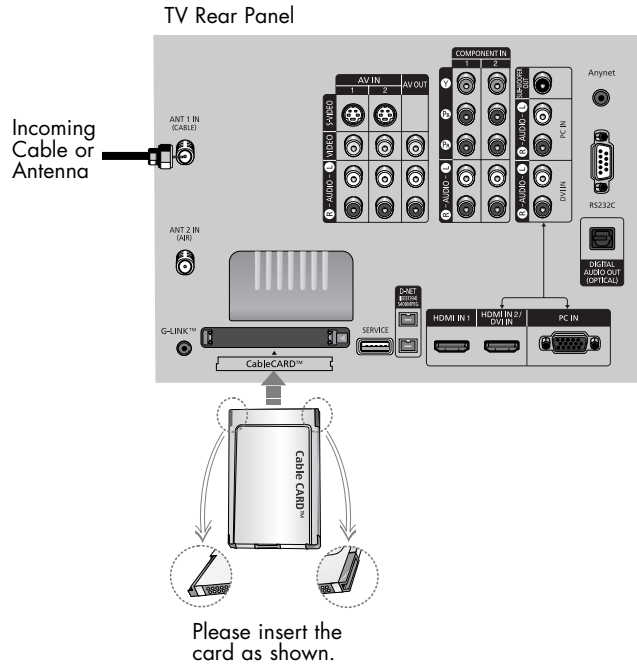

Connections

Connecting a Camcorder

The side panel jacks on your TV make it easy to connect a Camcorder to your TV. You can use your camcorder to view tapes without using a VCR.

- 1 Locate the A/V output jacks on the camcorder. They are usually found on the side or back of the camcorder.
- 2 Connect a video cable between the VIDEO IN (or S-VIDEO IN) jack on the TV and the VIDEO OUT jack on the Camcorder. The audio-video cables shown here are usually included with a Camcorder. (If not, check your local electronics store.) If your Camcorder is stereo, you need to connect a set of two cables.
- 3 Connect a set of audio cables between the AUDIO IN jacks on the TV and the AUDIO OUT jacks on the camcorder. If you have a mono Camcorder, connect L(mono) to the Camcorder audio out using only one audio cable.

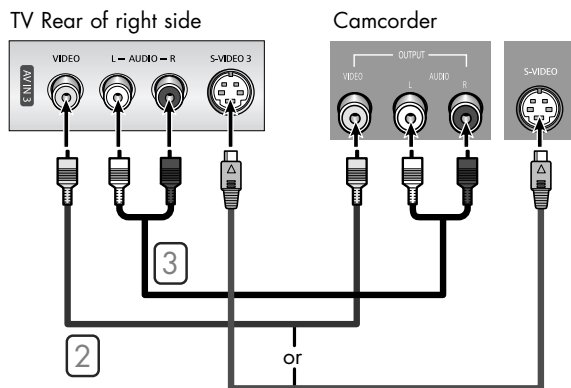
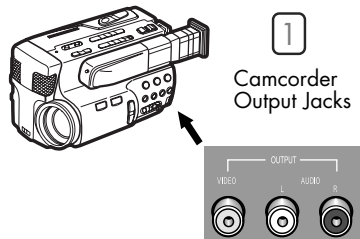

Connecting a DVD Player

The rear panel jacks on your TV make it easy to connect a DVD player to your TV.

Connecting to Y, Pb, Pr

- 1 To enable Component video viewing, connect a set of video cables between the COMPONENT (1 or 2) VIDEO (Y, Pb, Pr) IN jacks on the TV and VIDEO (Y/Pb/Pr or Y/Cb/Cr) OUT jacks on the DVD player.
- 2 Connect a set of audio cables between the COMPONENT (1 or 2) AUDIO (L, R) IN jacks on the TV and the AUDIO OUT jacks on the DVD player.

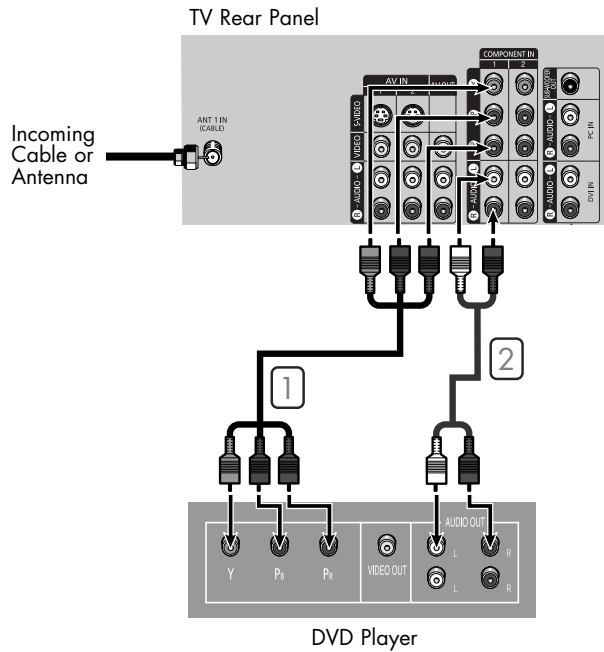

Connecting to Audio and Video Jacks

- 1 Connect a video cable between the VIDEO IN (1 or 2) jack on the TV and the VIDEO OUT jack on the DVD player.
- 2 Connect a set of audio cables between the AUDIO IN (1 or 2) jacks on the TV and the AUDIO OUT jacks on the DVD player.

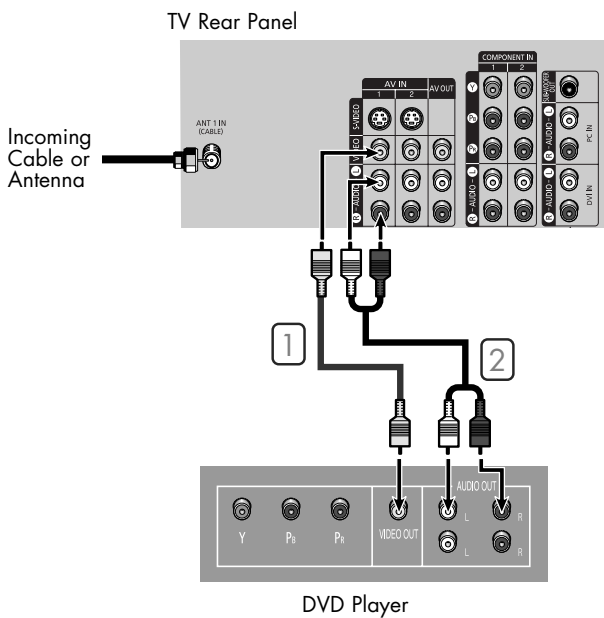

NOTE

- For an explanation of Component video, see your DVD player's owner's manual.

Connections

Connecting a DTV Set-Top Box

Connecting to Y, Pb, PR

- 1 Connect a set of Component cables between the COMPONENT (1 or 2) VIDEO (Y, Pb, PR) IN jacks on the TV and VIDEO (Y/Pb/PR or Y/Cb/Cr) OUT jacks on the Set-Top Box.
- 2 Connect a set of audio cables between the COMPONENT (1 or 2) AUDIO (L, R) IN jacks on the TV and the AUDIO OUT jacks on the Set-Top Box.

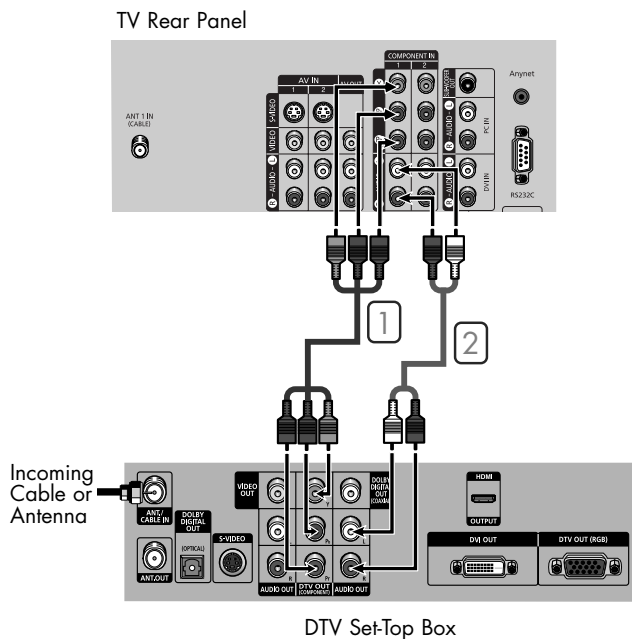

Connecting to DVI (Digital Visual Interface)

- 1 Connect an HDMI/DVI cable between the HDMI IN2/DVI IN jack on the TV and the DVI OUT jack on the Set-Top Box.
- 2 Connect a set of audio cables between the DVI AUDIO (L, R) IN jacks on the TV and the AUDIO OUT jacks on the Set-Top Box.

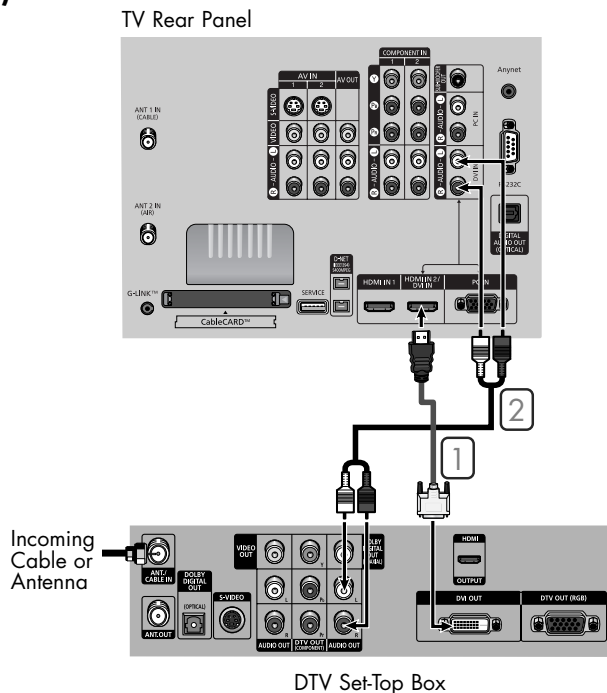

NOTES

- For an explanation of Component video, see your Set-Top Box owner's manual.
- Requires a Cable Converter.
- To use the TV Guide On Screen™, you have to connect the G-LINK™ cable.
- Make sure the HDMI/DVI source's power is on, or you will be unable to select it in the TV menu's source list.

Connecting a VCR and DTV Set-Top Box

1 Connect the Video/Audio cables between the VIDEO or S-VIDEO/AUDIO input jacks on the TV and VIDEO or S-VIDEO/AUDIO output jacks on the VCR.

2 Connect the Video/Audio cables between the VIDEO or S-VIDEO/AUDIO input jacks on the TV and VIDEO or S-VIDEO/AUDIO output jacks on the Set-Top Box.

3 Use the coaxial cable to connect between the splitter and the ANT 1 IN (CABLE) on the TV and between the splitter and the ANT IN on the Set-Top Box.

4 Connect a coaxial cable between the Antenna in terminal on the VCR and the Antenna out terminal on the Set-Top Box.

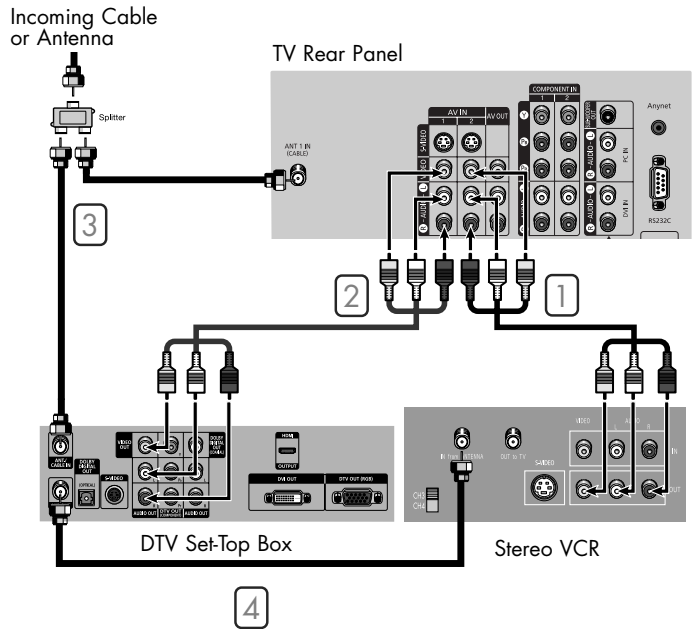

Connecting to HDMI (High Definition Multimedia Interface)

1 Connect an HDMI cable between the HDMI IN1 jack on the TV and the HDMI OUT jack on the Set-Top Box.

NOTES

- For an explanation of Component video, see your Set-Top Box owner's manual.

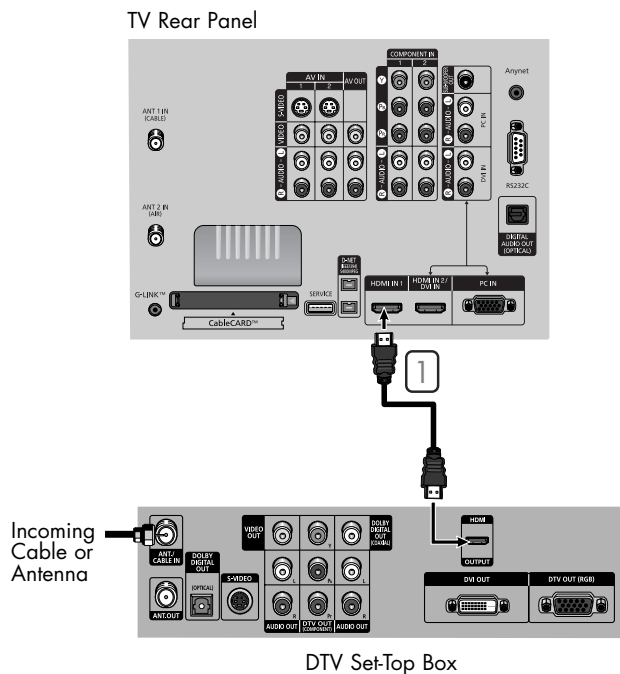

Connections

Connecting a Digital Audio System

There are many types of digital audio systems on the market today.

A simplified illustration of an audio system is shown below. For more information, see your audio system owner's manual.

- 1 If your audio system has an optical digital audio input, connect to the "DIGITAL AUDIO OUT(OPTICAL)" jack on the TV.

NOTE

- **OPTICAL:** converts the electric signal into an optical light signal, and transmits it through glass fibers.
See page 82 to set the digital output format (Dolby Digital or PCM) appropriate to your digital audio component.

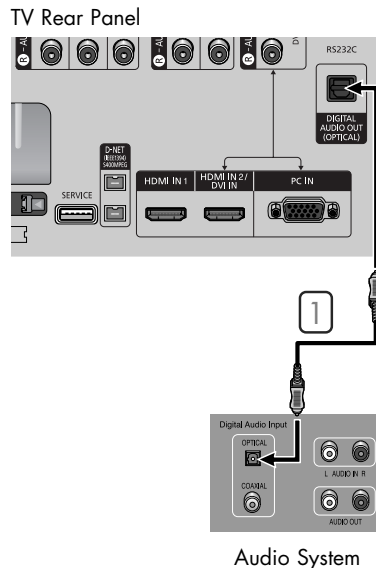

Connecting to an Analog Amplifier

- 1 The "AV OUT (AUDIO L/R)" terminals cannot be used for external speakers. You must hook them up to an amplifier.

When an audio amplifier is connected to the "AV OUT (AUDIO L/R)" terminals: Decrease the gain (volume) of the audio amplifier, turn the TV's internal mute on and adjust the volume level with the volume control of the amplifier.

NOTE

- If using the HDMI/DVI, PC, or Component input on the TV, the audio output signal is available only when the TV's Internal Mute is set to on.
(Refer to page 83)

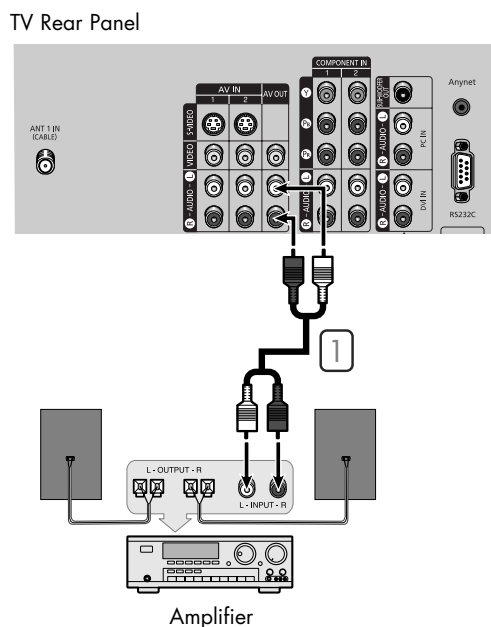

Connecting to a Subwoofer Speaker

1 Connect a powered subwoofer to the SubWoofer jack on the TV using the subwoofer cable.

2 To use a passive subwoofer, connect an amplifier and use referring to the connection procedures described in "Connecting to an Analog Amplifier".

NOTE

- *Powered subwoofer: This is a subwoofer with a built-in amplifier.*
- *Passive subwoofer: This is a subwoofer without a built-in amplifier. You have to install an additional amplifier and connect to the the subwoofer.*

TV Rear Panel

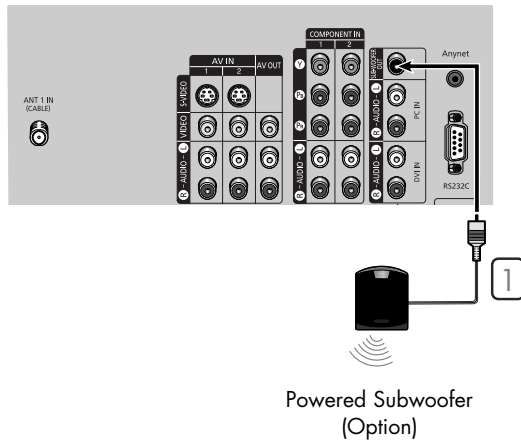

TV Rear Panel

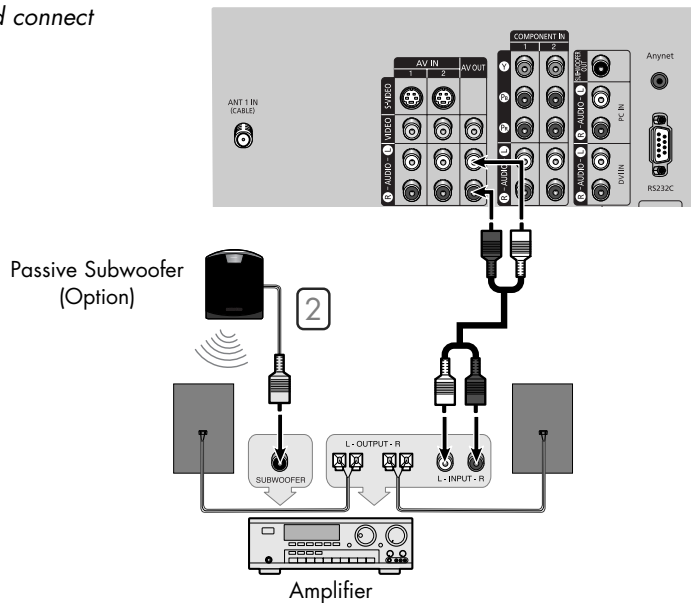

SAMSUNG



Operation

Operation

Turning the TV On and Off

Press the POWER button on the remote control.

You can also use the POWER button on the front panel.

When turning the TV on for the first time, the TV Guide screen will be displayed.

For more information, refer to the TV Guide Manual.

Viewing the Menus and On-Screen Displays

The on-screen menu system allows you to control the settings of your TV. Access the on-screen menu system by pressing the MENU button on the remote control. Once the on-screen menu appears, use the ▲/▼/◀/▶/ENTER buttons on your remote control to select menu items and make adjustments. You can also view the on-screen menu system and make some adjustments using the TV's side panel buttons.

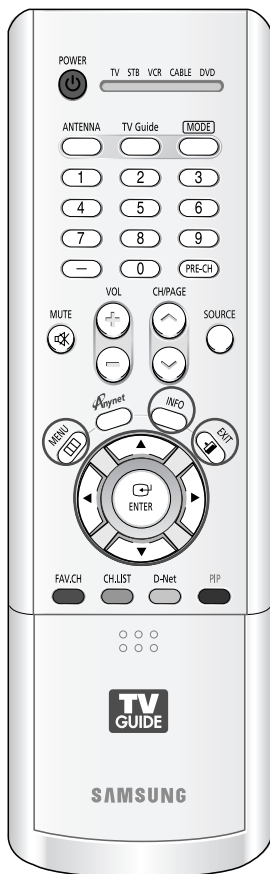

Viewing the Menus

- 1 Press the MENU button.
The main menu is displayed.
There are six menu groups: "Input", "Picture", "Sound", "Channel", "Setup", and "Listings".

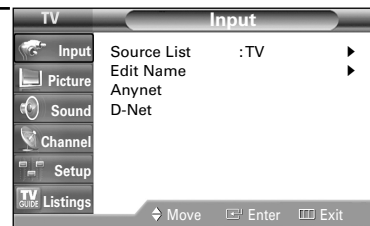

- 2 Press the ▲ or ▼ button to select an item you want in the menu.
Press the ◀, ▶ or ENTER button to display, change, or use the selected items.
Use the ENTER button to enter items in the menu.

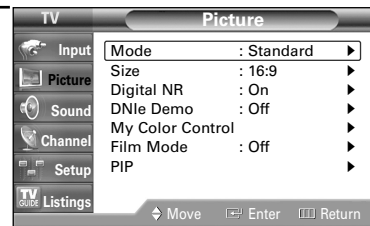

- 3 Press the EXIT button to exit.

Viewing the Display

Press the INFO button on the remote control.

The TV displays the current channel, the status of certain picture and sound settings and the current time.

The information displayed varies according to the selected source.

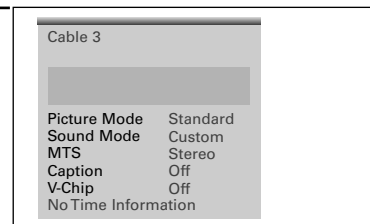

Selecting a Menu Language

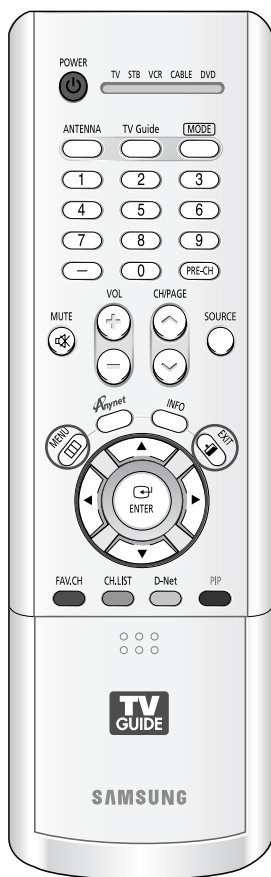

1 Press the MENU button.
Press the ▲ or ▼ button to select "Setup", then press the ENTER button.

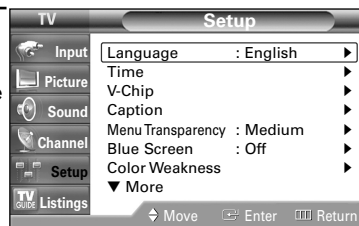

2 Press the ENTER button to select "Language".
Press the ▲ or ▼ button to select "English", "Español" or "Français", then press the ENTER button.

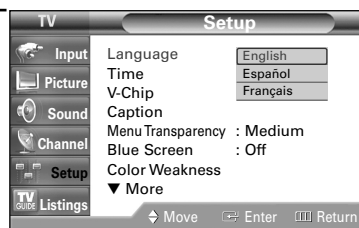

Press the EXIT button to exit.

Operation

Memorizing the Channels

Your TV can memorize and store all of the available channels for both "off-air" (antenna) and cable channels. After the available channels are memorized, use the CH/PAGE \wedge and CH/PAGE \vee buttons to scan through the channels. This eliminates the need to change channels by entering the channel digits. There are three steps for memorizing channels: selecting a broadcast source, memorizing the channels (automatic) and adding and deleting channels (manual).



Selecting the Video Signal Source

Before your television can begin memorizing the available channels, you must specify the type of signal source that is connected to the TV (i.e., an antenna or cable system).

- 1 Press the MENU button.
Press the \blacktriangle or \blacktriangledown button to select "Channel", then press the ENTER button.

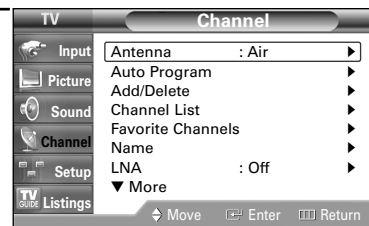

- 2 Press the ENTER button to select "Antenna".
Press the \blacktriangle or \blacktriangledown button to select "Air" or "Cable", then press the ENTER button.

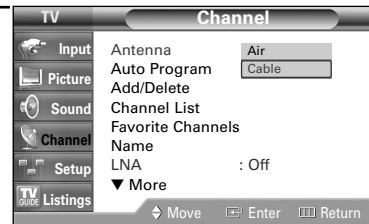

- 3 Press the \blacktriangle or \blacktriangledown button to select "Auto Program", then press the ENTER button.

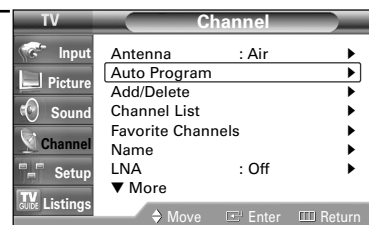

4 Press the ▲ or ▼ button to select the Antenna connection, then press the ENTER button.

- Air : "Air" antenna signal
Cable : "Cable" antenna signal
Air+Cable : "Air" and "Cable" antenna signals
- If the CableCARD is inserted into the "CableCARD" slot on the rear panel, "Cable" and "Air+Cable" are not available.

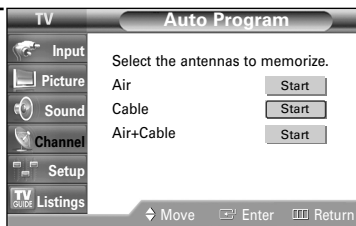

When selecting Cable TV system:
Press the ENTER button to start the auto program. By default, the cable TV system is set to "STD".

If you want to select another type of cable system, press the ◀ button and use the ▲ or ▼ button to select Analog or Digital "STD", "HRC" or "IRC". Press the ENTER button.

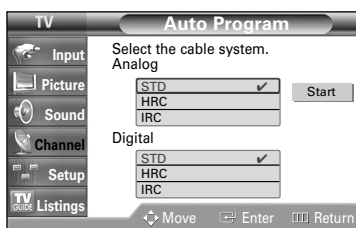

- STD, HRC and IRC identify various types of cable TV systems. Contact your local cable company to identify the type of cable system that exists in your particular area. At this point the signal source has been selected.

5 Press the ▶ button to select "Start", then press the ENTER button to start the auto program. The TV begins memorizing all available stations. Press the ENTER button at any time to interrupt the memorization process.

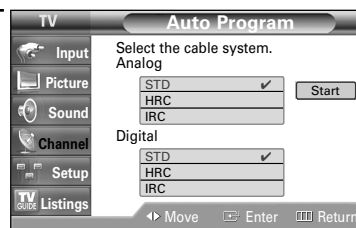

Press the EXIT button to exit.

- The TV must be connected to an antenna in order to receive digital TV signals. Even if a particular channel is deleted from the memory, you can always tune to that channel directly by using the number buttons on the remote control.

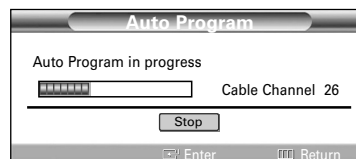

NOTE

- All available DTV and analog channels are automatically stored in memory.
- When the Cable card is inserted, you do not need to save channels.

Operation

Adding and Erasing Channels

You can add channels that were not memorized (or delete unwanted channels from memory).

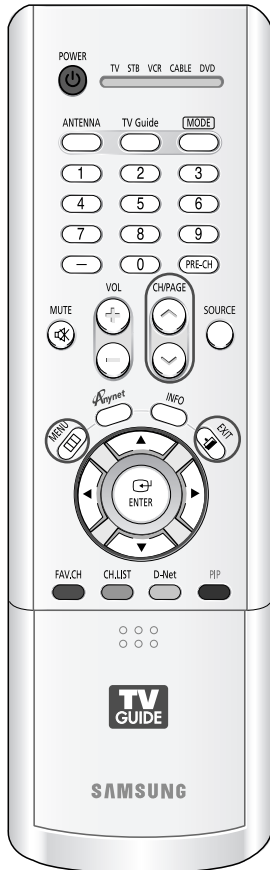

- 1 Press the MENU button. Press the ▲ or ▼ button to select "Channel", then press the ENTER button.

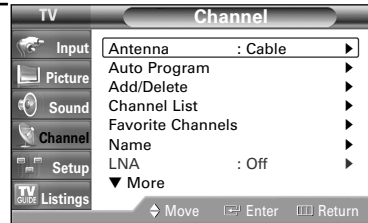

- 2 Press the ▲ or ▼ button to select "Add/Delete", then press the ENTER button.

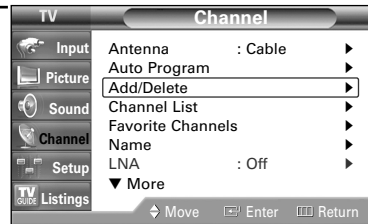

- 3 Repeatedly pressing the ENTER button will alternate between add channel and delete channel. Press the CH/PAGE ▲ or CH/PAGE ▼ button to switch to the appropriate channel, then repeat above.

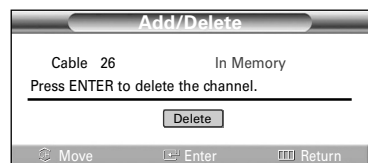

Press the EXIT button to exit.

Changing Channels

Using the Channel Buttons

Press the CH/PAGE \wedge or CH/PAGE \vee button to change channels.

When you press the CH/PAGE \wedge or CH/PAGE \vee button, the TV changes channels in sequence. You will see all the channels that the TV has memorized.

(The TV must have memorized at least three channels.)

You will not see channels that were either erased or not memorized.

Using the Number Buttons

Use the number buttons to quickly switch to any channel.

Press the number buttons to go directly to a channel. For example, to select channel 27, press "2," then "7." The TV will change channels when you press the second number.

Using the "-" Button

The "-" button is used to select stations that broadcast both a digital and analog signal.



For example, for channel 7-1 (digital), press "7", then "-", then "1".

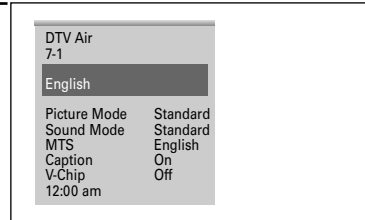

For channel 7-2 (analog), press "7", then "-", then "2".

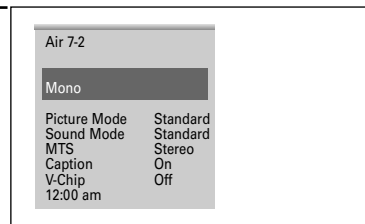

NOTE

- HD indicates the TV is receiving a Digital High Definition signal.
SD indicates the TV is receiving an Analog standard definition signal.

Using the Previous Channel

Press the PRE-CH button.

The TV changes to the last channel you were watching.

Operation

Customizing Your Remote Control

Your TV comes equipped with a universal remote control. In addition to controlling the TV, the universal remote control can also operate a VCR, Cable box, DVD, and some Samsung Set-top boxes (even if your VCR, Cable box and DVD are made by manufacturers other than Samsung).

NOTE

- The remote control might not be compatible with all DVD Players, VCRs, Cable boxes, and Set-Top Boxes.

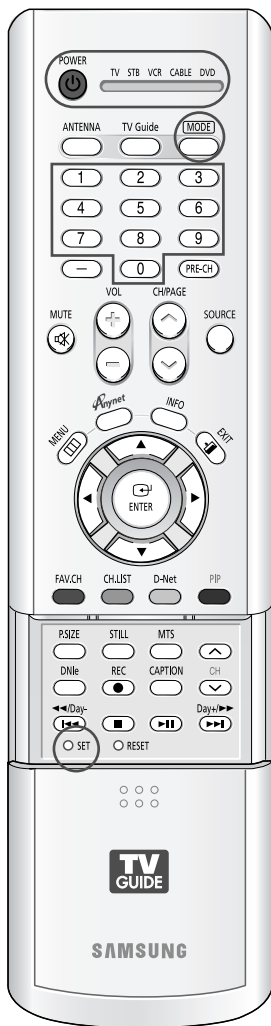

Setting Up Your Remote Control to Operate Your VCR (Cable box or DVD player)

- 1 Turn off your VCR (Cable box or DVD player).
- 2 Press the MODE button to switch the remote control to the VCR (CABLE or DVD) mode.
The remote control has five modes: TV, STB, VCR, CABLE, and DVD.
- 3 On your Samsung remote control, press the SET button.
- 4 Enter 3 digits of the VCR (Cable box or DVD player) code listed on next page for your brand of VCR (Cable box or DVD player). Make sure you enter 3 digits of the code, even if the first digit is a "0". (If more than one code listed, try the first one.)
- 5 Press the POWER button. Your VCR (Cable box or DVD player) should turn on. If your VCR (Cable box or DVD player) turns on, your remote control is now set correctly.
If your VCR (Cable box or DVD player) does not turn on, repeat steps 2, 3, and 4, but try one of the other codes listed for the brand of your particular VCR (Cable box or DVD player).
- 6 Once your remote control is set up, press the MODE button any time you want to use the remote to operate your VCR (Cable box or DVD player).

NOTES

- When your remote is in the TV mode, the VCR (or DVD player) control buttons (REW, STOP, PLAY/PAUSE, and FF) will still operate your VCR (or DVD player).
- When your remote control is in the STB, VCR, CABLE, or DVD mode, the volume buttons still control your TV's volume.

Remote Control Codes

VCR Codes

Admiral	015,088	Hitachi	014,024,044,045	Quasar	017,053
Aiwa	024	Instant Replay	017	Radio Shack	011,015,017,018,021,024,028,036,052,062
Akai	026,031,032	JC Penny	011,014,016,017,023,025,039,044,060,062	RCA	009,014,016,017,037,044,046,063,078
Audio Dynamics	022,025	JCL	011,017,023,025,039,055	Realistic	011,015,017,018,021,024,028,036,052,062
Bell & Howell	011	Kenwood	011,023,025,039,055	Samsung	000,016,022,031,041,051
Broksonic	019	KLH	082	Sansui	025
Candle	016,018,022,054,055,061	LG(Goldstar)	001,002,007,018,023,055,069	Sanyo	011,021
Canon	017,062	Lloyd	024	Scott	022,050,058,077
Citizen	016,018,022,054,055,061	Logik	040	Sears	011,014,018,021,027,028,044,052,057
Colortyme	023	LXI	024	Sharp	015,036,048,054
Craig	016,021	Magnavox	017,038,062,065	Shintom	026,035,040,064
Curtis Mathes	009,016,017,023,024,055,062,073,076	Marantz	011,017,023,025,038,039,055,070	Signature	024
Daewoo	003,004,005,006,007,008,022,054,085	MTC	016,024	Sony	026,035,047
DB	023,025	Multitech	016,024,040,041	Sylvania	017,024,038,062,065
Dimensia	009	NEC	011,023,025,039,055,070,073	Symphonic	024
Dynatech	024	Optimus	015	Tandy	011,024
Electrohome	036	Panasonic	017,062,084,086	Tatung	039
Emerson	017,018,019,022,024,029,032,036,043,050,051,056,058,066,071,074,076,077,079	Pentax	014,044	Teac	024,039,078
Fisher	011,021,027,028,052,057,067	Pentex Research+	055	Technics	017
Funai	024	Philco	017,038,062,065	teknika	017,018,024,030
General Electric	009,016,017,041,062	Philips	017,038	TMK	076
Go Video	016	Pioneer	014,025,042,059	Toshiba	014,022,028,057,058
Harman Kardon	023	Portland	053,054,061	Toshiko	018
		PROSCAN	009	Television	016,018
		Quartz	011		

Cable Box Codes

Anvision	015,016	Magnavox	015,016,027,029,034,036,037,040,041,048,049	Signature	054
Cable Star	015,016	Nawoo	001	Sprucer	035
DaeHan	005	NSC	017	Starcom	054
DeaRyung	003	Oak	024,046	Stargate2000	066
DongKuk	004	Osk Sigma	024	Sylvania	019,067
Eagle	015,016	Panasonic	011,035,047,069	TaePyungYang	002
Eastern International	020	Philips	015,016,027,029,034,036,037,040,041,048,049	Texscan	019,067
General Instrument	054	Pioneer	026,028,052	Tocom	025,029,057,058,063
GI	012,013,023,031,032,033,038,044,075,076,077	Randtek	015,016	Unika	039,040,049
Hamlin	011,012,020,021,042,056	RCA	008,035,074	Universal	059,060
Hitachi	045,051,054	Regal	011,020,021	Viewstar	015,016,027,029,034,036,037,040,041,048,049
Jerrold	012,013,023,031,032,033,038,044,054,070,073	Regency	010,041	Warner Amex	052
LG(Goldstar)	006	Saewoo	007	Zenith	022,050,065,069
Macom	045,051	Samsung	000,011,030,052,071,072		

DVD Codes

Curtis Mathes	009	Philips	007	Sharp	005
JVC	003	PROSCAN	008	Sony	004
LG(Goldstar)	001	RCA	008	Toshiba	002
Panasonic	006	Samsung	000		

Operation

Setting the Clock

Setting the clock is necessary in order to use the various timer features of the TV. Also, you can check the time while watching the TV. (Just press the INFO button.)



Option 1: Setting the Clock Manually

- 1 Press the MENU button. Press the ▲ or ▼ button to select "Setup", then press the ENTER button.

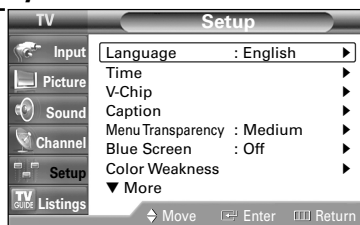

- 2 Press the ▲ or ▼ button to select "Time", then press the ENTER button. Press the ENTER button to select "Clock".

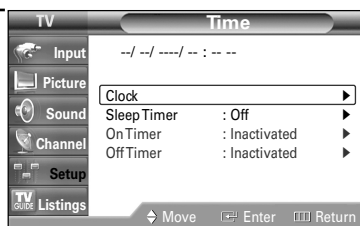

- 3 Press the ENTER button to select "Clock Mode". Press the ▲ or ▼ button to select "Manual", then press the ENTER button.

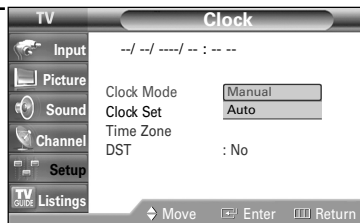

- 4 Press the ▲ or ▼ button to select "Clock Set", then press the ENTER button.

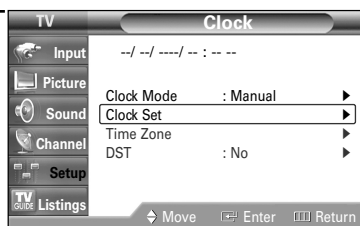

- 5 Press the ◀ or ▶ button to move to "Month", "Day", "Year", "Hour", "Minute", or "am/pm". Set the clock you want by pressing the ▲ or ▼ button, then press the ENTER button.

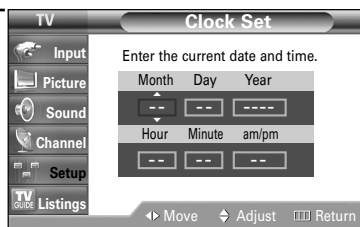

- You can set the month, day, year, hour and minute directly by pressing the number buttons on the remote control.

Press the EXIT button to exit.

NOTE

- The current time will appear every time you press the INFO button.

Option 2: Setting the Clock Automatically

The Clock can be set automatically if you are receiving a digital signal.

- 1 Press the MENU button.
Press the ▲ or ▼ button to select "Setup", then press the ENTER button.

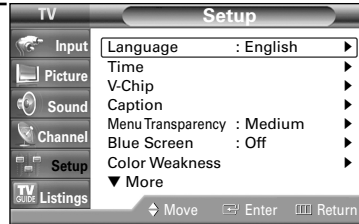

- 2 Press the ▲ or ▼ button to select "Time", then press the ENTER button.
Press the ENTER button to select "Clock".

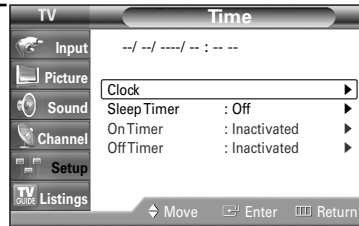

- 3 Press the ENTER button to select "Clock Mode".
Press the ▲ or ▼ button to select "Auto", then press the ENTER button.

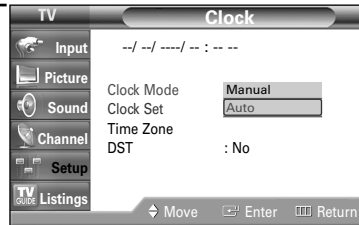

- 4 Press the ▲ or ▼ button to select "Time Zone", then press the ENTER button.

Press the ▲ or ▼ button to highlight the time zone for your local area (and to move the highlight to the appropriate time zone on the map of the United States), then press the ENTER button.



- When you set up Auto Time, the set time may not be correct depending on the broadcasting station and signal. If there is a difference between the real time and set time, please set the time manually.

- 5 Press the ▲ or ▼ button to select "DST"(Daylight Saving Time), then press the ENTER button.
Press the ▲ or ▼ button to select "Yes" or "No", then press the ENTER button.

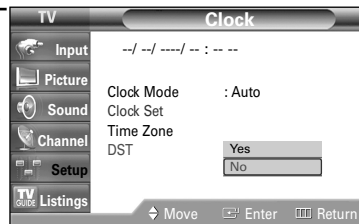

Press the EXIT button to exit.

Operation

Setting the On/Off Timer



NOTE

• Auto Power Off

When you set the timer "On", the television will eventually turn off, if no controls are operated for 3 hours after the TV was turned on by the timer. This function is only available in timer "On" mode and prevents overheating or leakage, which may occur if a TV is on for too long (when you are on vacation, for example).

- 1 Press the MENU button.
Press the ▲ or ▼ button to select "Setup", then press the ENTER button.

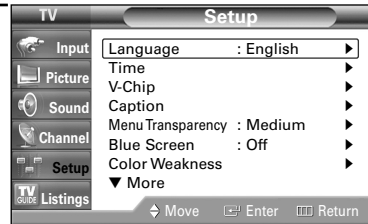

- 2 Press the ▲ or ▼ button to select "Time", then press the ENTER button.
Press the ▲ or ▼ button to select "On Timer", then press the ENTER button.
Press the ▲ or ▼ button to adjust "Hour", then press the ► button to move to the next step.
Set other items using the same method as above.

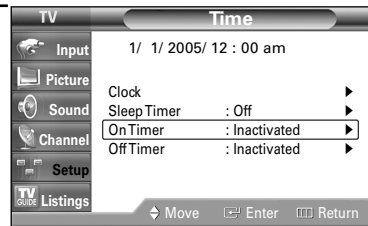

To activate On Timer with the setting entered, set Activation to "Yes" by pressing ▲ or ▼ button.

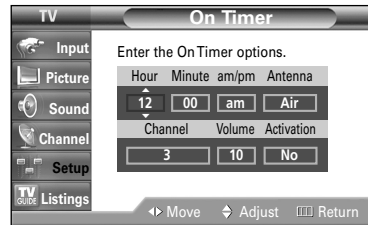

- You can set the hour, minute, channel, and volume directly by pressing the number buttons on the remote control.

When finished, press the MENU button to return.

- 3 Press the ▲ or ▼ button to select "Off Timer", then press the ENTER button.
Press the ▲ or ▼ button to adjust "Hour", then press the ► button to move to the next step. Set other items using the same method as above.

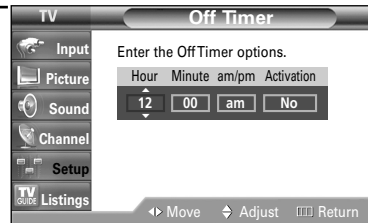

To activate Off Timer with the setting entered, set Activation to "Yes" by pressing ▲ or ▼ button.

When finished, press the EXIT button to exit.

Setting the Sleep Timer

The sleep timer automatically shuts off the TV after a preset time (from 30 to 180 minutes).



- 1 Press the MENU button.
Press the ▲ or ▼ button to select "Setup", then press the ENTER button.

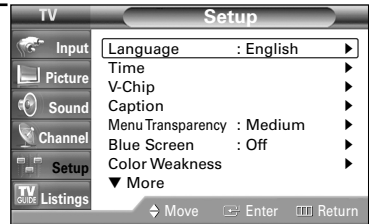

- 2 Press the ▲ or ▼ button to select "Time", then press the ENTER button.
Press the ▲ or ▼ button to select "Sleep Timer", then press the ENTER button.

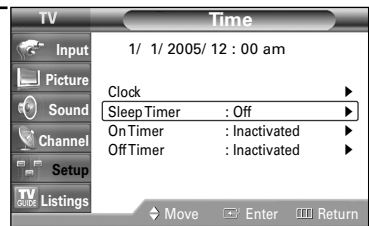

- 3 Press the ▲ or ▼ button to adjust "Minute".



- 4 Setting the Timer sets the Activation to "Yes" automatically.

Press the EXIT button to exit.



Operation

Viewing an External Signal Source

Use the remote control to switch between viewing signals from connected equipment, such as a VCR, DVD, Set-Top Box or the TV source (broadcast or cable).



Setting the Signal Source

- 1 Press the MENU button.
Press the ENTER button to select "Input".

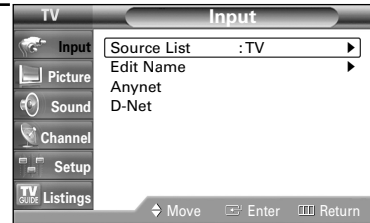

- 2 Press the ENTER button to select "Source List".
Press the ▲ or ▼ button to select a signal source, then press the ENTER button.

- When you connect equipment to the TV, you can choose between the following sets of jacks: "AV1", "AV2", "S-VIDEO1", "S-VIDEO2", "COMPONENT1", "COMPONENT2", "PC", "HDMI1", or "HDMI2" on the TV's rear panel and "AV3" or "S-VIDEO3" on the TV's side panel.
- HDMI input can be selected only when the external device is turned on and connected to the TV.

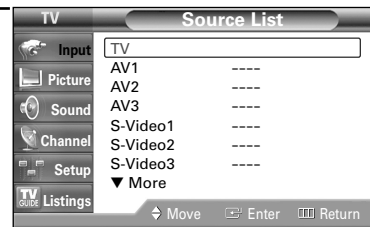

Alternate method

Press the SOURCE button on the remote control repeatedly to select an external signal source.

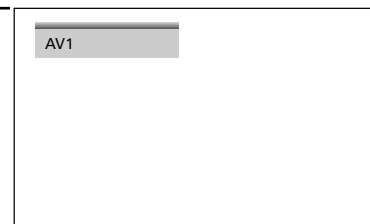

Assigning Names to External Input Mode

This feature enables you to name the input source you have connected.



- 1 Press the MENU button.
Press the ENTER button to select "Input".

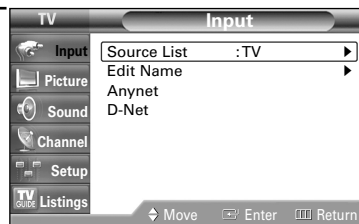

- 2 Press the ▲ or ▼ button to select "Edit Name", then press the ENTER button.

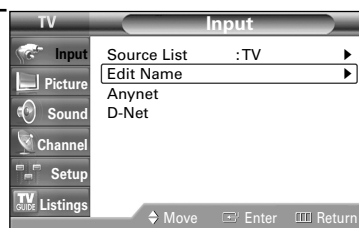

- 3 Press the ▲ or ▼ button to select a signal source to edit, then press the ENTER button.

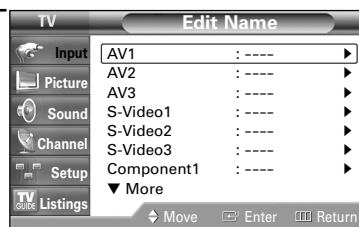

- 4 Press the ▲ or ▼ button to select the external device : VCR, DVD, D-VHS, Cable STB, HD STB, Satellite STB, PVR STB, AV Receiver, DVD Receiver, GAME, Camcorder, DVD Combo, DVD HDD Recorder, PC, Internet TV Recv., Interactive TV Recv., VOD (Video On Demand) STB, TV.

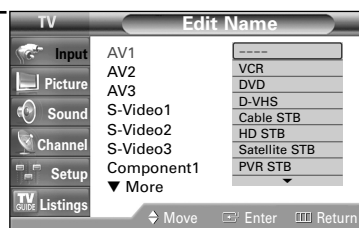

Press the ENTER button.
Set other signal sources (AV2, AV3, S-Video1, S-Video2, S-Video3, Component1, Component2, PC, HDMI1, HDMI2) using the same method as listed above.

Press the EXIT button to exit.

SAMSUNG



Channel Control



Channel Control

Selecting Your Favorite Channels

You can store your favorite channels for each available input source (such as TV and CATV). This allows you to quickly and easily find frequently watched channels by pressing the FAV.CH button on the remote control.



To Store Your Favorite Channels:

- 1 Press the MENU button. Press the ▲ or ▼ button to select "Channel", then press the ENTER button.

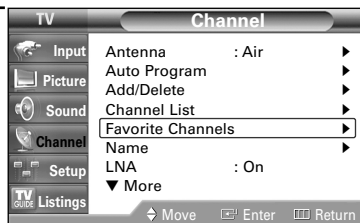

- 2 Press the ▲ or ▼ button to select "Favorite Channels", then press the ENTER button. Press the ▲ or ▼ button to select a channel, then press the ENTER button and a check mark will appear. Press the ENTER button again to deselect the selected channel and the check mark will disappear.

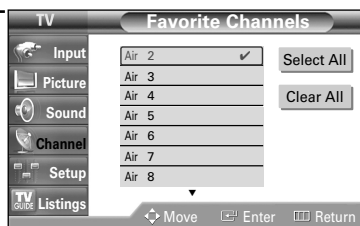

Press the EXIT button to exit.

NOTES

- Only memorized channels can be set as Favorite channels.
- Select All : Press to select all channels.
- Clear All : Press to clear all channels.

To View Your Favorite Channels:

Press the FAV.CH button repeatedly to jump from one favorite channel to another.

Viewing the Channel Lists

You can display a list of all channels or your favorite channels.



1 Press the MENU button. Press the ▲ or ▼ button to select "Channel", then press the ENTER button.

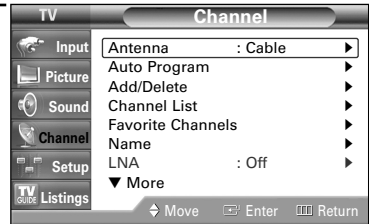

2 Press the ▲ or ▼ button to select "Channel List", then press the ENTER button.

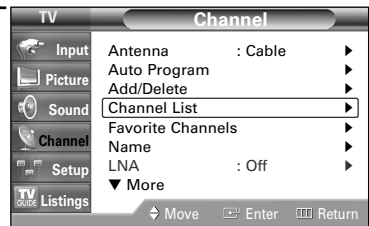

3 Press the ▲ or ▼ button to select "All" or "Favorite", then press the ENTER button.



Press the CH/PAGE ^ or CH/PAGE v button to display the previous or next channel list page.

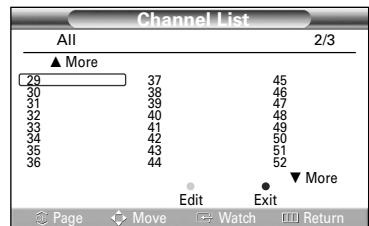

- Yellow button : Press to edit channels. The edit channel menu is displayed. (See next page for details.)
- Green button : Press to toggle between your all or favorite channels.
- Blue or EXIT button : Press to exit.

Alternate method

Press the CH.LIST button on the remote control to display a list of channels.

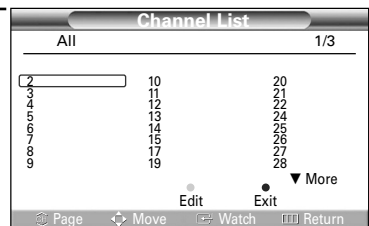

Channel Control

Adding and Erasing Channels



1 Press the MENU button.
Press the ▲ or ▼ button to select "Channel", then press the ENTER button.

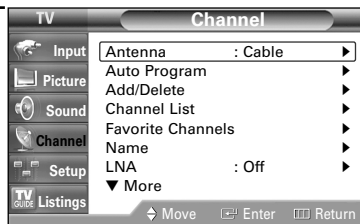

2 Press the ▲ or ▼ button to select "Channel List", then press the ENTER button.

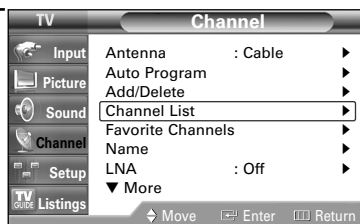

3 Press the ▲ or ▼ button to select "Edit", then press the ENTER button.



4 Press the ▲ or ▼ button to change channels you want to add or delete.
Repeatedly pressing ENTER button will alternate between "Add" and "Delete".

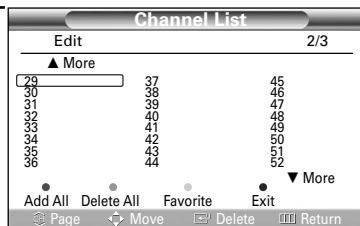

Press the ▲ or ▼ button to select the favorite channel you want to add, then press the yellow button.
The check (✓) mark will appear.
Press the yellow button again to deselect the selected channel and the check (✓) mark will disappear.

Press the CH/PAGE ▲ or CH/PAGE ▼ button to display the previous or next channel list page.

- Red button : Press to add all channels of the channel list.
- Green button : Press to delete all channels of the channel list.
- Yellow button : Press to add favorite channels.
- Blue or EXIT button : Press to exit.

Labeling the Channels

Use this feature to assign an easy-to-remember label to analog channels (i.e., "CBS", "ESPN", "PBS2", CNN02", etc.) A label consists of five fields, where each field is a letter, a number or a blank. When the INFO button is pressed, the channel label will appear below the channel number.

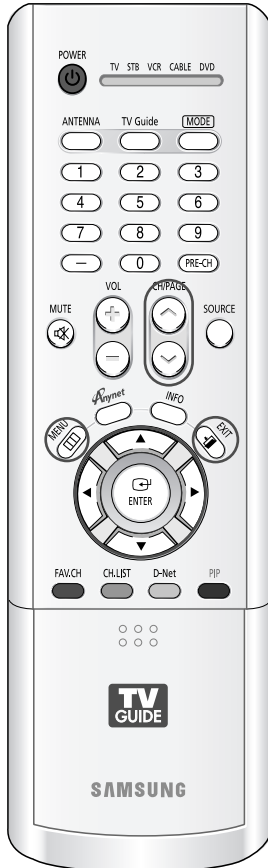

NOTE

- If you add or delete a TV channel, the labeled channels will also be added or deleted.

1 Press the CH/PAGE \wedge or CH/PAGE \vee button to tune to the channel that will be labeled.

2 Press the MENU button. Press the \blacktriangle or \blacktriangledown button to select "Channel", then press the ENTER button. Press the \blacktriangle or \blacktriangledown button to select "Name", then press the ENTER button.

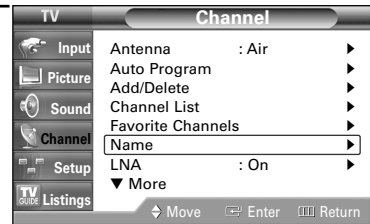

3 Press the \blacktriangle or \blacktriangledown button to move to the channel to be assigned to a new name, then press the ENTER button. Press the \blacktriangle or \blacktriangledown button to select a letter, a number or a blank. (Results in this sequence: A...Z, 0...9, +, -, *, /, blank).

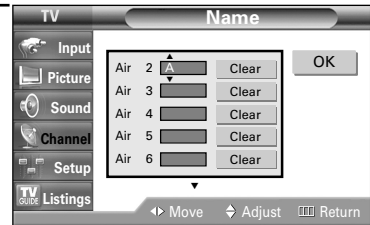

4 Press the \blacktriangleright button to switch to the next field, which will be selected. Select a second letter or digit by pressing \blacktriangle or \blacktriangledown button, as above. Repeat the process to select the last three digits. When you have finished, press the ENTER button. To erase the assigned new name, select "Clear" by pressing the \blacktriangleleft or \blacktriangleright button, then press the ENTER button.

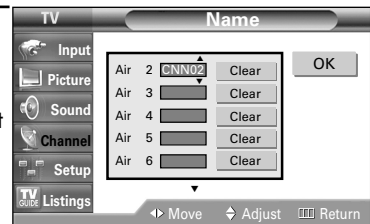

Press the EXIT button to exit.

Channel Control

LNA (Low Noise Amplifier)

If the TV is operating in a weak-signal area, sometimes the LNA function can improve the reception (a low-noise preamplifier boosts the incoming signal).



- 1 Press the MENU button.
Press the ▲ or ▼ button to select "Channel", then press the ENTER button.

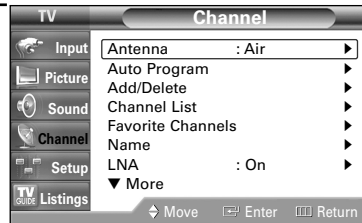

- 2 Press the ▲ or ▼ button to select "LNA", then press the ENTER button.

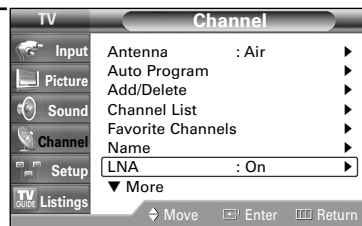

- 3 Press the ▲ or ▼ button to select "On" or "Off", then press the ENTER button.

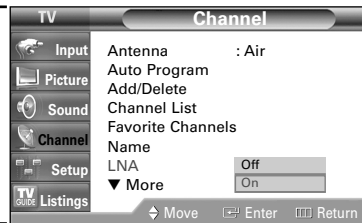

- 4 Press the EXIT button to exit.

NOTES

- LNA functions only when antenna is set to Air.
The settings will be stored separately in each channel.
- If the picture is noisy with the LNA set to On, select Off.
- The LNA setting must be made separately for each channel.

Fine Tuning Analog Channels **Analog**

Use fine tuning to manually adjust a particular channel for optimal reception.



NOTE

- Only analog TV channels can be fine tuned.

- 1 Press the MENU button.
Press the ▲ or ▼ button to select "Channel", then press the ENTER button.

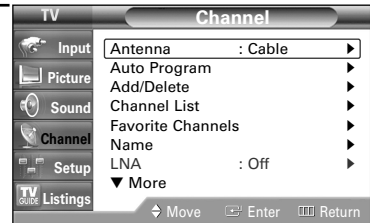

- 2 Press the ▲ or ▼ button to select "Fine Tune", then press the ENTER button.

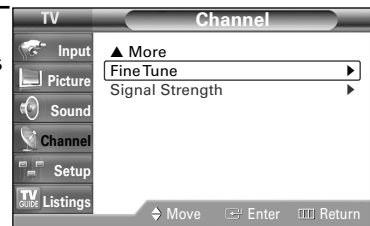

- 3 Press the ◀ or ▶ button to adjust the fine tuning.

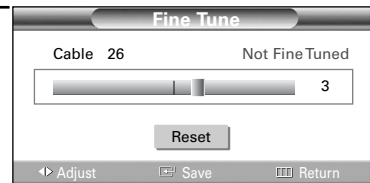

- 4 To store the fine tuning setting in the TV's memory, press the ENTER button. To reset the fine tuning setting, press the ▼ button to select "Reset", then press the ENTER button.

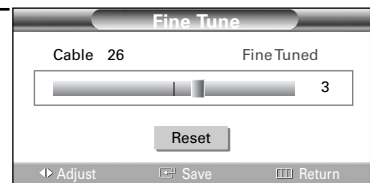

- 5 Press the EXIT button to exit.

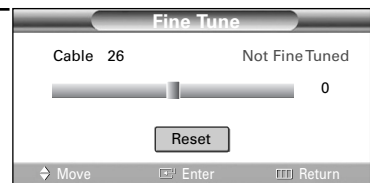

Channel Control

Checking the Digital-Signal Strength Digital

Unlike analog channels, which can vary in reception quality from “snowy” to clear, digital (HDTV) channels have either perfect reception quality or you will not receive them at all. So, unlike analog channels, you cannot fine tune a digital channel.

You can, however, adjust your antenna to improve the reception of available digital channels.



- 1 Press the MENU button.
Press the ▲ or ▼ button to select “Channel”, then press the ENTER button.

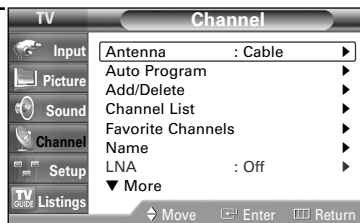

- 2 Press the ▲ or ▼ button to select “Signal Strength”, then press the ENTER button.

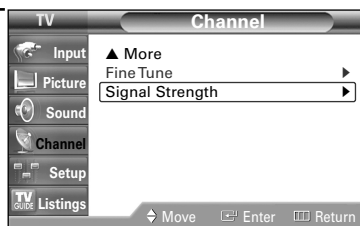

If the signal strength meter indicates that the signal is weak, physically adjust your antenna to increase the signal strength. Continue to adjust the antenna until you find the best position with the strongest signal.

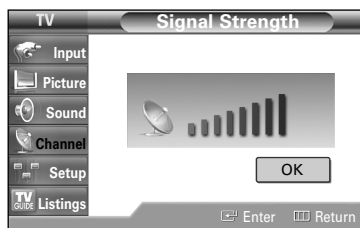

Press the EXIT button to exit.



Picture Control



Picture Control

Picture Control

You can select the type of picture which best corresponds to your viewing requirements.



Changing the Picture Standard

- 1 Press the MENU button.
Press the ▲ or ▼ button to select "Picture", then press the ENTER button.

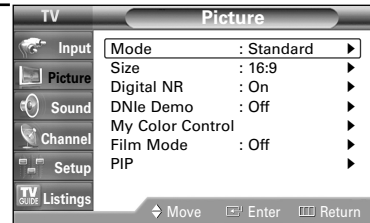

- 2 Press the ENTER button again to select "Mode".

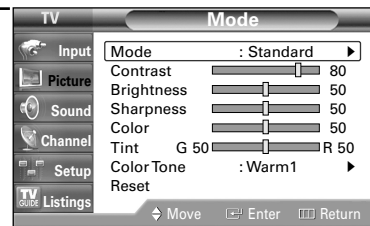

- 3 Press the ENTER button.
Press the ▲ or ▼ button to select the desired picture mode (Dynamic, Standard, Movie, Custom), then press the ENTER button.

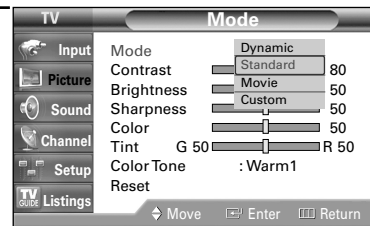

Press the EXIT button to exit.

- Choose "Dynamic" for viewing the TV during the day or when there is a bright light in the room.
- Choose "Standard" for the standard factory settings.
- Choose "Movie" when viewing the movie.
- Choose "Custom" if you want to adjust the settings according to personal preference (see "Customizing the Picture Settings", page 55).

Customizing the Picture Settings

You can use the on-screen menus to change the "Contrast", "Brightness", "Sharpness", "Color", "Tint", and "Color Tone" according to personal preference. You can select "Standard" which automatically recalls your personalized picture settings.

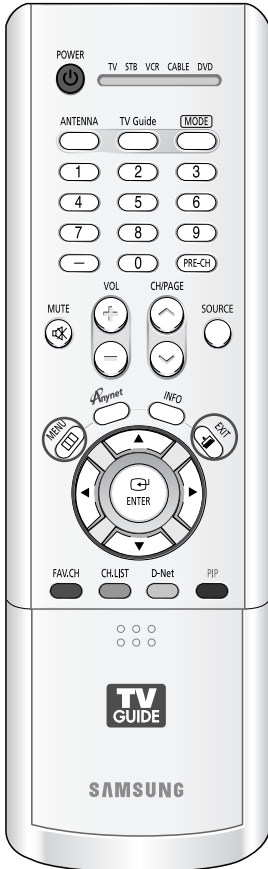

1 Press the MENU button. Press the ▲ or ▼ button to select "Picture", then press the ENTER button.

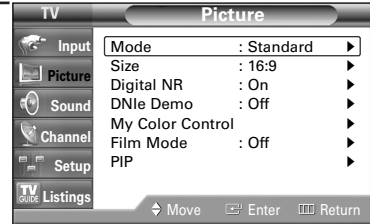

2 Press the ENTER button to select "Mode".

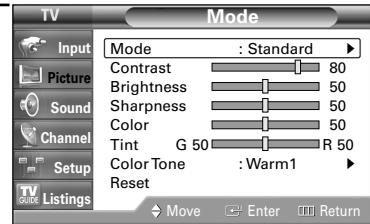

3 Press the ENTER button. Press the ▲ or ▼ button to select the desired picture mode (Dynamic, Standard, Movie, Custom), then press the ENTER button.

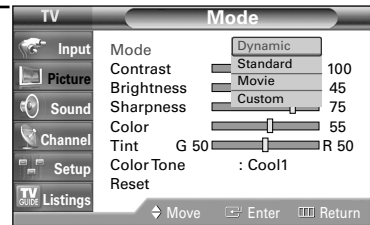

4 Press the ▲ or ▼ button to select a particular option (Contrast, Brightness, Sharpness, Color, or Tint), then press the ENTER button.

Press the ◀ or ▶ button to decrease or increase the value of a particular item.

- You can also select these options (Contrast, Brightness, Sharpness, Color, or Tint) by pressing the ▲ or ▼ button.

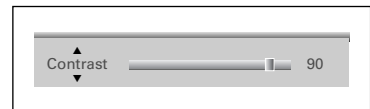
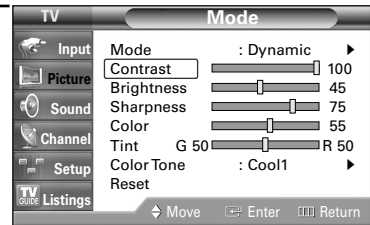

NOTES

- "Tint" doesn't operate in HDMI or 480p Component or higher modes.
- The Tint cannot be adjusted while watching Digital TV.

Continued...

Picture Control

- 5 Press the ENTER button to return to "Mode".
Press the ▲ or ▼ button to select "Color Tone", then press the ENTER button.

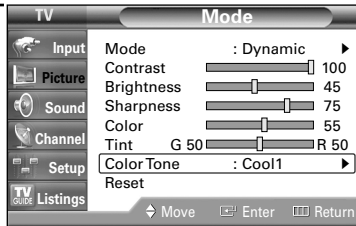

- 6 Press the ▲ or ▼ button to select a particular item (Cool2, Cool1, Normal, Warm1, or Warm2), then press the ENTER button.

Press the EXIT button to exit.

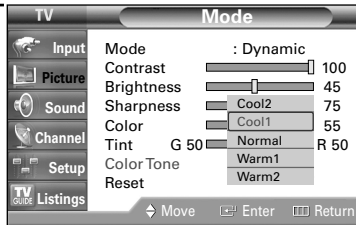

NOTE

- Color tone is not available in the "Movie" picture mode.

Resetting the Picture Settings to the Factory Defaults

- 7 To return the factory defaults, select "Reset" by pressing the ▲ or ▼ button. Press the ENTER button.

- The previously adjusted settings will be reset to the factory defaults.

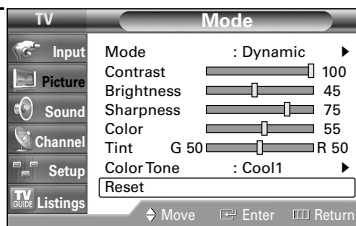

NOTE

- The reset function is set for each mode (Dynamic, Standard, Movie, or Custom).

Changing the Picture Size

You can select the picture size which best corresponds to your viewing requirements.



- 1 Press the MENU button.
Press the ▲ or ▼ button to select "Picture", then press the ENTER button.
Press the ▲ or ▼ button to select "Size", then press the ENTER button.

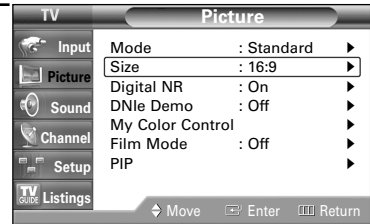

- 2 Press the ◀ or ▶ button to select the screen format you want, then press the ENTER button.

Press the EXIT button to exit.

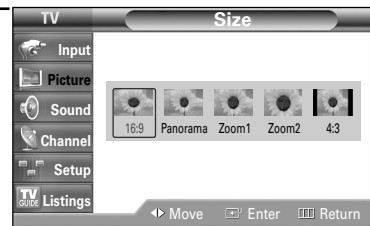

Alternate method

Press the P.SIZE button on the remote control repeatedly to select one of the picture size settings.

- "16:9": Sets the picture to 16:9 wide mode.
- "Panorama": Sets the picture to the wide aspect ratio of a panoramic picture.
- "Zoom1": Magnifies the size of the picture on screen.
- "Zoom2": Magnifies the size of the picture more than "Zoom1".
- "4:3": Sets the picture to 4:3 normal mode.
This is a standard TV screen size.

NOTES

- You can select only the 16:9 and 4:3 screen sizes in the DTV or Component (720p, 1080i) mode.
- When Double (◻◻, ◻◻) mode has been set in PIP, the Picture Size cannot be set.
- For Zoom1 and Zoom2, you can adjust the size by using the ▲ or ▼ button after pressing the P.SIZE button under the remote's cover.

Picture Control

Digital Noise Reduction

If the broadcast signal received by your TV is weak, you can activate the Digital Noise Reduction feature to help reduce any static and ghosting that may appear on the screen.



- 1 Press the MENU button.
Press the ▲ or ▼ button to select "Picture", then press the ENTER button.

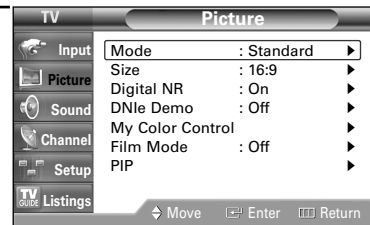

- 2 Press the ▲ or ▼ button to select "Digital NR", then press the ENTER button.

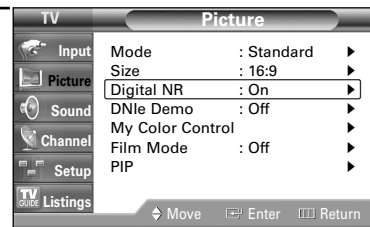

- 3 Press the ▲ or ▼ button to select "Off" or "On", then press the ENTER button.

Press the EXIT button to exit.

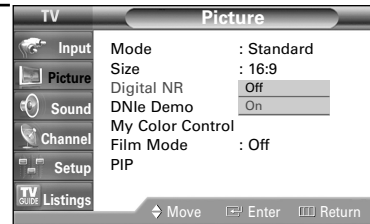

Viewing the DNle Demonstration

This TV includes the DNle function so as to provide a high visual quality. If you set DNle Demo to On, you can view an applied DNle and normal picture on the screen simultaneously, for demonstration purposes. Using this function, you can view the difference in the visual quality.



- 1 Press the MENU button.
Press the ▲ or ▼ button to select "Picture", then press the ENTER button.

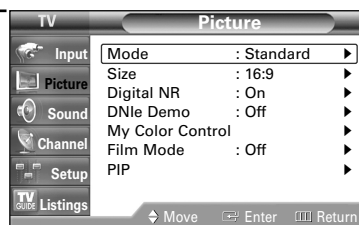

- 2 Press the ▲ or ▼ button to select "DNle Demo", then press the ENTER button.

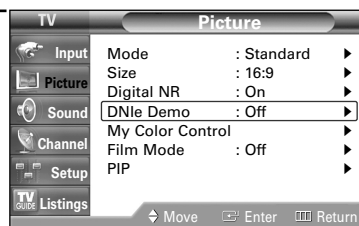

- 3 Press the ▲ or ▼ button to select "Off" or "On", then press the ENTER button.

Press the EXIT button to exit.

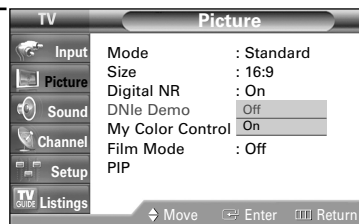

Alternate method

Press the DNle button on the remote control repeatedly to select one of the settings.

- On: Switches on the DNle Demo mode.
- Off: Switches off the DNle Demo mode.

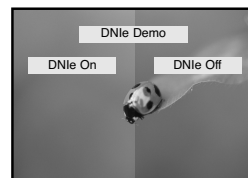

NOTE

- DNle™ (Digital Natural Image engine) **DNle™**
This feature brings you a more detailed image with 3D noise reduction and detail, contrast and white enhancement.

Picture Control

Setting the My Color Control Mode

My Color Control allows you to adjust colors according to your preference, by adjusting skin, sky, and grass tones using the predefined settings (Red, Green, Blue, Yellow, Pink, Standard, and Custom) without affecting other colors on the screen.

Using the My Color Control Function in the Easy Control Menu

Skin, sky and grass tones are easily adjustable to suit your preferences.



1 Press the MENU button. Press the ▲ or ▼ button to select "Picture", then press the ENTER button.

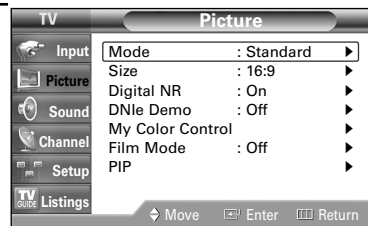

2 Press the ▲ or ▼ button to select "My Color Control", then press the ENTER button.

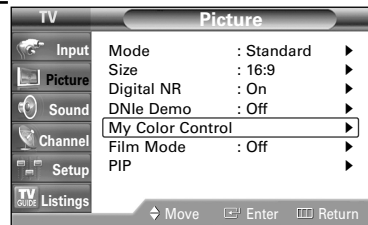

3 Press the ENTER button to select "Easy Control".



4 Press the ◀ or ▶ button to select the setting among the various picture settings. The original picture (before adjustment) is shown on the left side, while the selected mode is shown on the right side.



NOTE

- Changing the settings in the "Detail Control" menu (see page 61) will automatically set the My Color Control mode to "Custom".

- There are seven My Color Control modes: Red, Green, Blue, Yellow, Pink, Standard, and Custom.

Press the EXIT button to exit.

My Color Control Custom Settings

Users can adjust the 5 My Color Control colors (Red, Green, Blue, Yellow, and Pink).

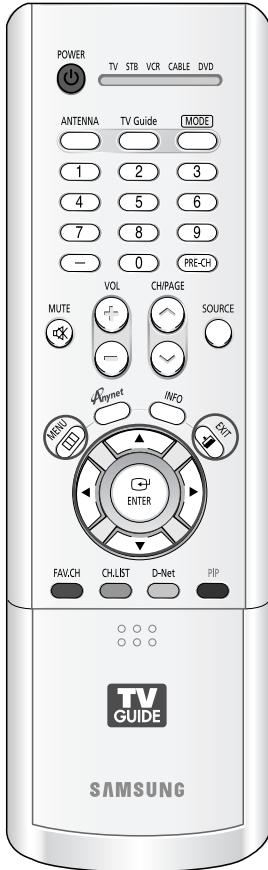

- 1 Press the MENU button. Press the ▲ or ▼ button to select "Picture", then press the ENTER button.
- 2 Press the ▲ or ▼ button to select "My Color Control", then press the ENTER button.
- 3 Press the ▲ or ▼ button to select "Detail Control", then press the ENTER button.
- 4 Press the ▲ or ▼ button to select the desired color and then press the ENTER or ► button.
 - The original picture (before adjustment) is shown on the left side, while the picture after adjustment is shown on the right side, and an adjustment bar is shown on the bottom of the screen.
- 5 Press the ◀ or ▶ button to adjust the settings. Press the ▲ or ▼ button to choose other colors.
- 6 Press the ENTER or MENU button to confirm the changes and return to the previous menu.

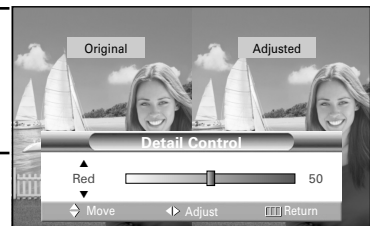
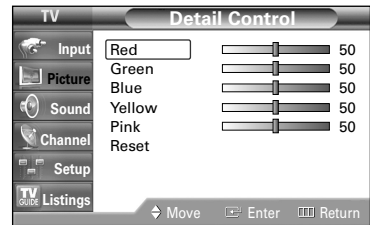
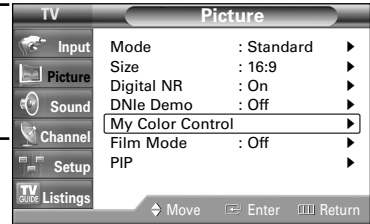

Resetting the My Color Control Colors to the Factory Defaults

You can return to the factory default settings for My Color Control colors.

- 7 Press the MENU button to display the "Detail Control" menu. Press the ▲ or ▼ button to select "Reset", then press the ENTER button. The previously adjusted My Color Control colors will be reset to the factory defaults.

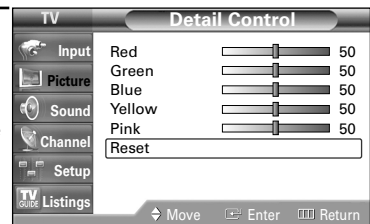

Picture Control

Using the Color Weakness Enhancement Feature

This feature adjusts the Red, Green or Blue color to enhance the picture according to the user's particular color weakness.



- 1 Press the MENU button.
Press the ▲ or ▼ button to select "Setup", then press the ENTER button.

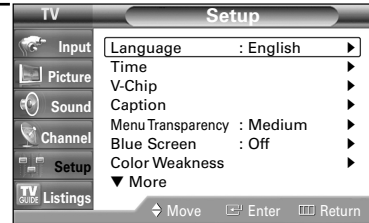

- 2 Press the ▲ or ▼ button to select "Color Weakness", then press the ENTER button.

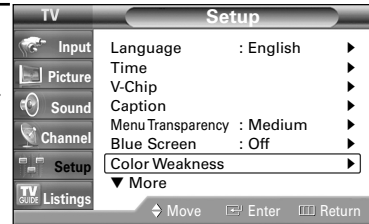

- 3 Press the ENTER button to select "Color Weakness".
Press the ▲ or ▼ button to select "On", then press the ENTER button.

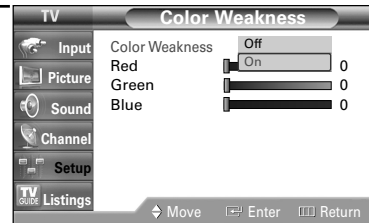

- 4 Press the ▲ or ▼ button to select a color to be adjusted, then press the ENTER button.

Press the ◀ or ▶ button to adjust the value of a color selected.

- You can also select these options (Red, Green or Blue) by pressing the ▲ or ▼ button.

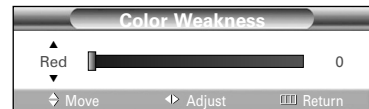
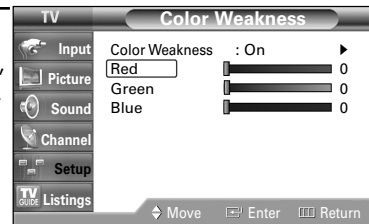

Press the EXIT button to exit.

Setting the Film Mode

You can automatically sense and process film signals from all sources and adjust the picture for optimum quality.



- 1 Press the MENU button.
Press the ▲ or ▼ button to select "Picture", then press the ENTER button.

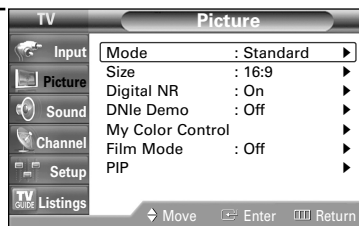

- 2 Press the ▲ or ▼ button to select "Film Mode", then press the ENTER button.

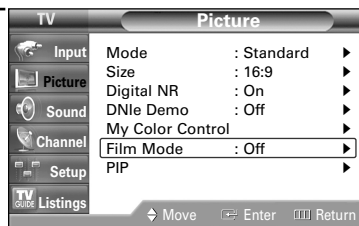

- 3 Press the ▲ or ▼ button to select "Off" or "On", then press the ENTER button.

Press the EXIT button to exit.

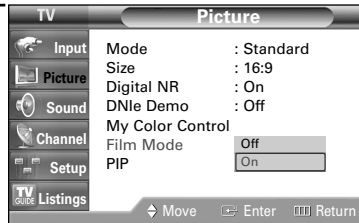

NOTE

- Film mode is supported in 480i only.

Picture Control

Viewing Picture-In-Picture

One of the best features of your TV is the Picture-In-Picture (PIP) feature. The advanced PIP system allows you to watch two different pictures at once, even if you don't have a VCR or DVD connected to your TV.

Activating the PIP



- 1 Press the MENU button. Press the ▲ or ▼ button to select "Picture", then press the ENTER button.

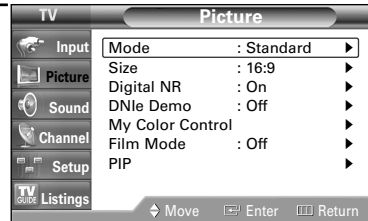

- 2 Press the ▲ or ▼ button to select "PIP", then press the ENTER button.

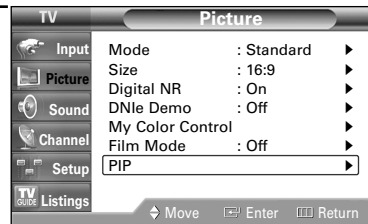

- 3 Press the ENTER button to select "PIP". Press the ▲ or ▼ button to select "On", then press the ENTER button. The sub picture appears in the corner of the screen.

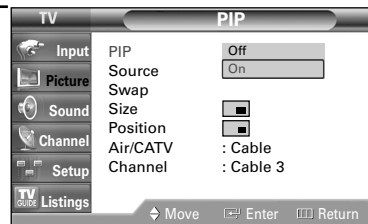

Press the EXIT button to exit.

Alternate method

Press the PIP button on the remote control repeatedly to activate or deactivate the PIP.

NOTES

- This feature doesn't function when the "V-Chip" is active.
- If you turn the TV off while watching and turn it on again, then the mode will return to normal video.
- Digital channels cannot be viewed in the PIP window.
- PIP is supported when the video source for the main picture is digital and the source for the sub picture is analog.
- PIP is supported even when both the main and the sub pictures are analog.
For more information, refer to the PIP Settings table on page 66.

Selecting an External Source

You can use PIP to view a signal from an external source, such as a VCR.



- 1 Press the MENU button.
Press the ▲ or ▼ button to select "Picture", then press the ENTER button.

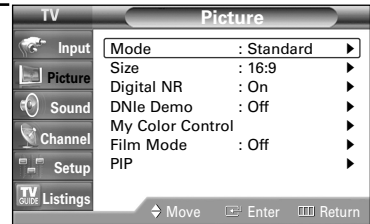

- 2 Press the ▲ or ▼ button to select "PIP", then press the ENTER button.

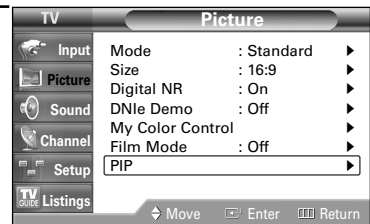

- 3 Press the ▲ or ▼ button to select "Source", then press the ENTER button.
If you have not connected any equipment to the TV's input jacks, the signal from these inputs will not appear.

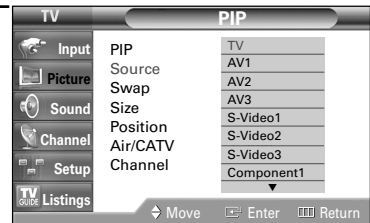

Press the ▲ or ▼ button to select an external signal, then press the ENTER button.

Press the EXIT button to exit.

NOTE

- For more information about external signals, see "Viewing an External Signal Source" (See page 42) and the "PIP Settings" (See page 66).

Picture Control

Swapping the Sub (PIP) Picture and Main Picture



1 Press the MENU button. Press the ▲ or ▼ button to select "Picture", then press the ENTER button.

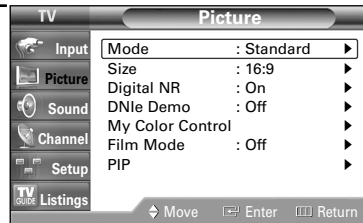

2 Press the ▲ or ▼ button to select "PIP", then press the ENTER button.

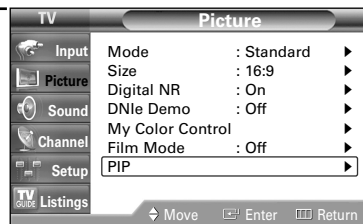

3 Press the ▲ or ▼ button to select "Swap", then press the ENTER button. The sub picture appears in the main picture, and vice versa.

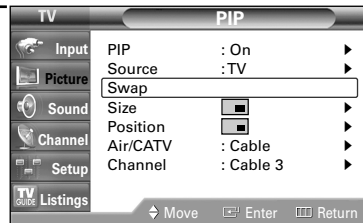

Press the EXIT button to exit.

NOTE

- SWAP is not available when the Main picture is a Digital broadcast.

PIP Settings

- : PIP and swap operate
- ▲ : PIP operates. Swap does not operate
- X : PIP doesn't operate

Sub \ Main	ATSC	QAM	NTSC	AV1	AV2	AV3	S-Video1	S-Video2	S-Video3	Component1	Component2	HDMI	PC	D-Net
ATSC	X	X	X	X	X	X	X	X	X	X	X	X	X	▲
QAM	X	X	X	X	X	X	X	X	X	X	X	X	X	▲
NTSC	▲	▲	○	○	○	○	○	○	○	○	○	▲	X	▲
AV1	▲	▲	○	X	○	○	○	○	○	○	○	▲	X	▲
AV2	▲	▲	○	○	X	○	○	○	○	○	○	▲	X	▲
AV3	▲	▲	○	○	○	X	○	○	○	○	○	▲	X	▲
S-Video1	▲	▲	○	○	○	○	X	○	○	○	○	▲	X	▲
S-Video2	▲	▲	○	○	○	○	○	X	○	○	○	▲	X	▲
S-Video3	▲	▲	○	○	○	○	○	○	X	○	○	▲	X	▲
Component1	▲	▲	○	○	○	○	○	○	○	X	○	▲	X	X
Component2	▲	▲	○	○	○	○	○	○	○	○	X	▲	X	X

Changing the Size of the Sub (PIP) Picture



- 1 Press the MENU button.
Press the ▲ or ▼ button to select "Picture", then press the ENTER button.

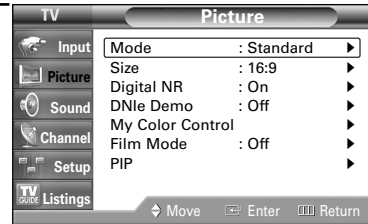

- 2 Press the ▲ or ▼ button to select "PIP", then press the ENTER button.

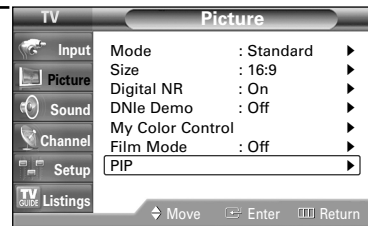

- 3 Press the ▲ or ▼ button to select "Size", then press the ENTER button.

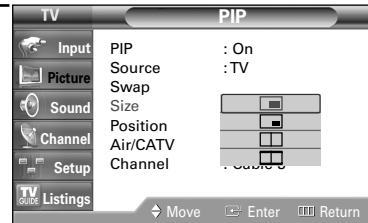

Press the ▲ or ▼ button to select a size you want, then press the ENTER button.

Press the EXIT button to exit.

Picture Control

Changing the Location of the Sub (PIP) Picture



- 1 Press the MENU button.
Press the ▲ or ▼ button to select "Picture", then press the ENTER button.

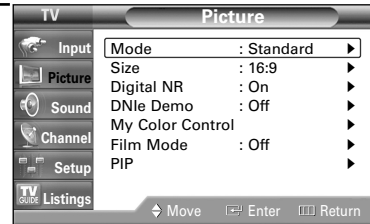

- 2 Press the ▲ or ▼ button to select "PIP", then press the ENTER button.

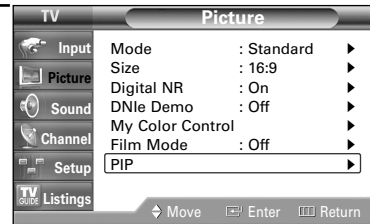

- 3 Press the ▲ or ▼ button to select "Position", then press the ENTER button.

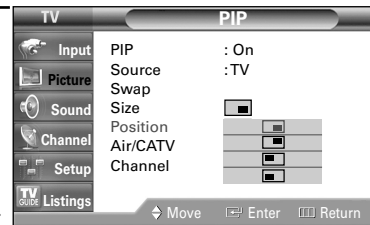

Press the ▲ or ▼ button to select a position you want, then press the ENTER button.

Press the EXIT button to exit.

NOTE

- In Double (□□, □□) mode, you cannot set the Position.

Selecting a Signal Source (Air or Cable) for PIP

If the PIP source is TV while PIP is On, you can select a different broadcasting source for the PIP picture from the main picture.

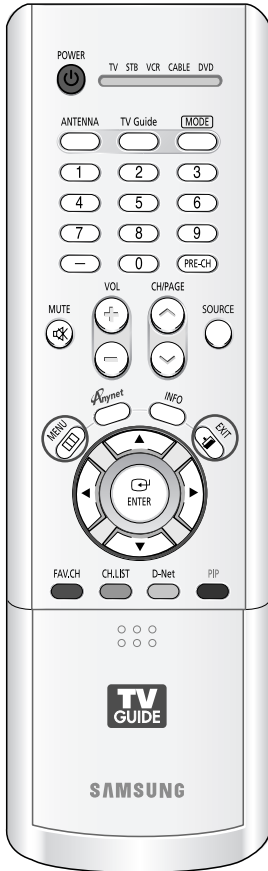

- 1 Press the MENU button.
Press the ▲ or ▼ button to select "Picture", then press the ENTER button.

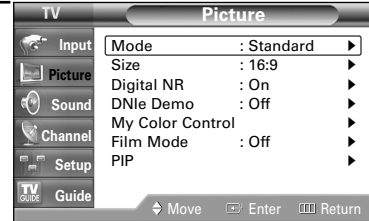

- 2 Press the ▲ or ▼ button to select "PIP", then press the ENTER button.

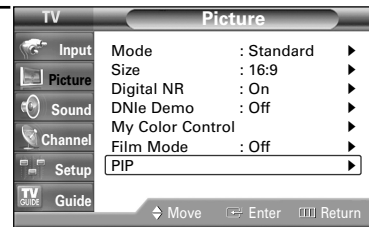

- 3 Press the ▲ or ▼ button to select "Air/CATV", then press the ENTER button.

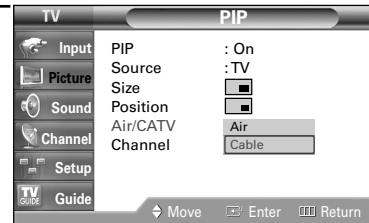

- 4 Press the ▲ or ▼ button to select "Air" or "Cable", then press the ENTER button.

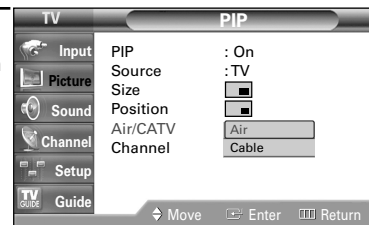

Press the EXIT button to exit.

Picture Control

Changing the Channel of the Sub (PIP) Picture

After you set the signal source (antenna or cable) of the sub picture, it is easy to change channels.



- 1 Press the MENU button.
Press the ▲ or ▼ button to select "Picture", then press the ENTER button.

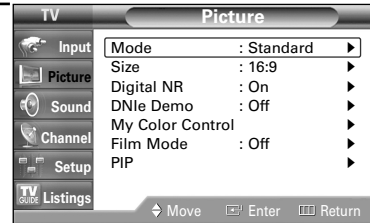

- 2 Press the ▲ or ▼ button to select "PIP", then press the ENTER button.

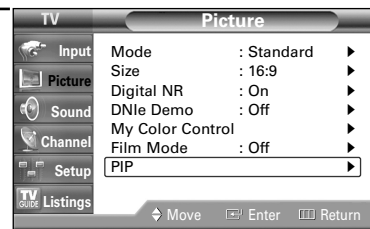

- 3 Press the ▲ or ▼ button to select "Channel", then press the ENTER button.

Press the ▲ or ▼ button to select a channel you want, then press the ENTER button.

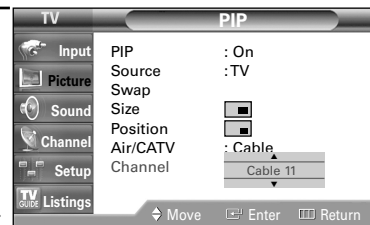

Press the EXIT button to exit.

- Air : "Air" antenna signal
Cable : "Cable" antenna signal

Alternate method

Press the CH ▲ or CH ▼ button under the cover of the remote control to change the sub picture channels while PIP is on.

Selecting the Sound Source

You can use this feature to hear sound from the main or sub (PIP) picture.

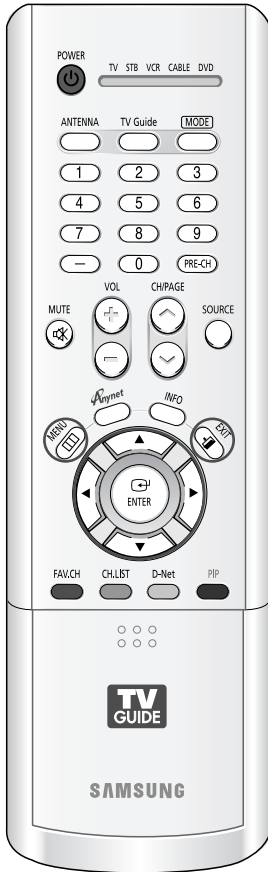

- 1 Press the MENU button.
Press the ▲ or ▼ button to select "Sound", then press the ENTER button.

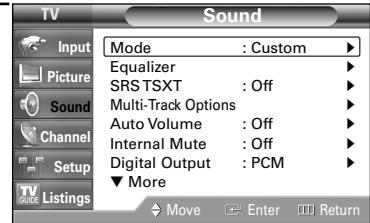

- 2 Press the ▲ or ▼ button to select "Sound Select", then press the ENTER button.
Press the ▲ or ▼ button to select "Main" or "Sub", then press the ENTER button.

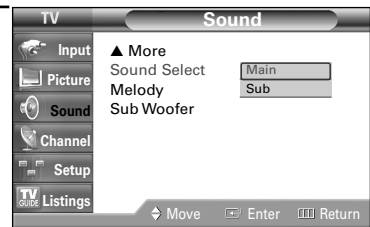

Press the EXIT button to exit.

Picture Control

Freezing the Picture

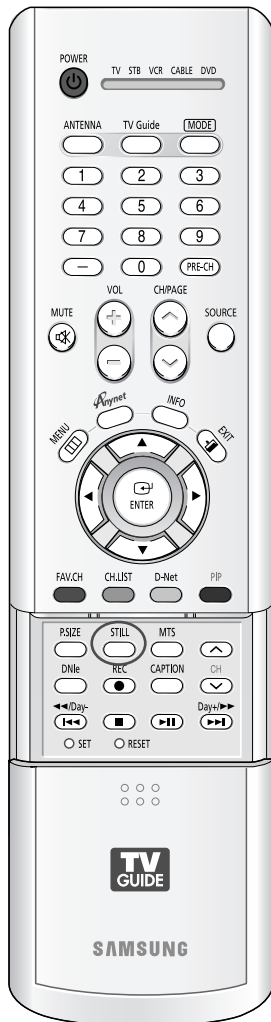

Press the STILL button to freeze a moving picture. (Normal sound will still be heard.)

Press again to cancel.

NOTE

- In the PIP mode, the main and sub pictures are stilled at the same time.

Setting the Blue Screen Mode

If no signal is being received or the signal is very weak, a blue screen automatically replaces the noisy picture background. If you wish to continue viewing the poor picture, you must set the "Blue Screen" mode to "Off".



- 1 Press the MENU button.
Press the ▲ or ▼ button to select "Setup", then press the ENTER button.

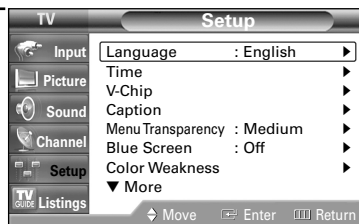

- 2 Press the ▲ or ▼ button to select "Blue Screen", then press the ENTER button.

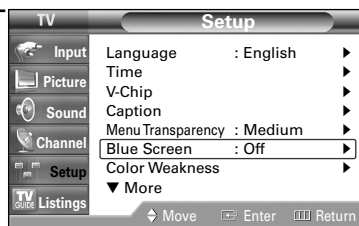

- 3 Press the ▲ or ▼ button to select "On" or "Off", then press the ENTER button.

Press the EXIT button to exit.

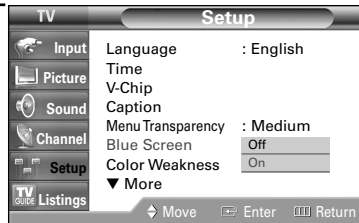

SAMSUNG



Sound Control



Sound Control

Sound Control

You can control and customize the sound levels and settings of the TV with the remote control.



Adjusting the Volume

Press the VOL+ or VOL- button to increase or decrease the volume.

Using the MUTE Button

At any time, you can temporarily cut off the sound.

Press the MUTE button on the remote control.

The message "Mute" is displayed and the sound cuts off.

To turn mute off, press the MUTE button again or press either the VOL+ or VOL- button.



Customizing the Sound

The sound settings can be adjusted to suit your personal preference. (Alternatively, you can use one of the automatic settings. See next page.)

- 1 Press the MENU button. Press the ▲ or ▼ button to select "Sound", then press the ENTER button.

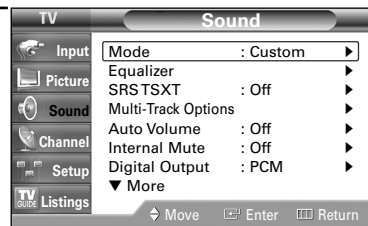

- 2 Press the ▲ or ▼ button to select "Equalizer", then press the ENTER button.

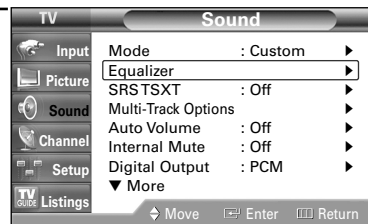

Continued...

- 3 Press the ◀ or ▶ button to select a particular item to be changed. Press the ▲ or ▼ button to increase or decrease the selected frequency.

Press the EXIT button to exit.

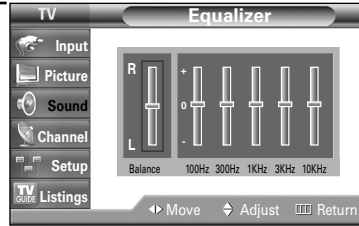

Notes

- If you make any changes to the equalizer settings, the sound mode is automatically switched to the custom mode.
- **L/R Sound Balance Adjustment**
To adjust the sound balance of the L/R speakers.
- **Bandwidth Adjustment (100, 300, 1K, 3K, 10K)**
To adjust the level of different bandwidth frequencies.

Using Automatic Sound Settings

Your TV has automatic sound settings ("Standard", "Music", "Movie", and "Speech") that are preset at the factory. You can select "Custom", which automatically recalls your personalized sound settings.

- 1 Press the MENU button. Press the ▲ or ▼ button to select "Sound", then press the ENTER button.

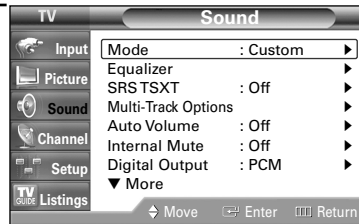

- 2 Press the ENTER button to select "Mode". Press the ▲ or ▼ button to select a particular item, then press the ENTER button.

Press the EXIT button to exit.

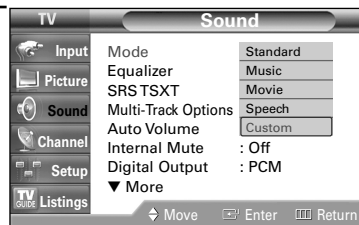

- Choose "Standard" for the standard factory settings.
- Choose "Music" when watching music videos or concerts.
- Choose "Movie" when watching movies.
- Choose "Speech" when watching a show that is mostly dialog (i.e., news).
- Choose "Custom" to recall your personalized settings.

Sound Control

Setting the SRS TSXT

TruSurround XT is a patented SRS technology that solves the problem of playing 5.1 multichannel content over two speakers. Trusurround delivers a compelling, virtual surround sound experience through any two-speaker playback system, including internal television speakers. It is fully compatible with all multichannel formats.



- 1 Press the MENU button.
Press the ▲ or ▼ button to select "Sound", then press the ENTER button.

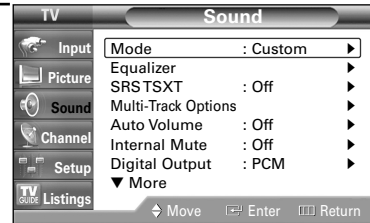

- 2 Press the ▲ or ▼ button to select "SRS TSXT", then press the ENTER button.

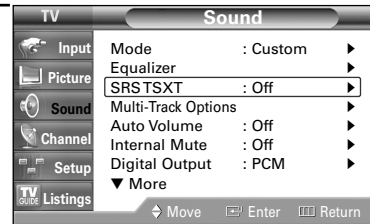

- 3 Press the ▲ or ▼ button to select "Off", "3D Mono" or "Stereo", then press the ENTER button.

Press the EXIT button to exit.

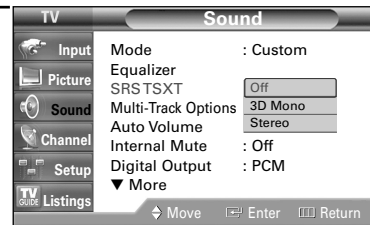

NOTE

- Press the INFO button on the remote control to see the current status of sound settings.

Auto Volume

Each broadcasting station has its own signal conditions, and it is inconvenient to adjust the volume every time the channel is changed. "Auto Volume" automatically adjusts the volume of the desired channel by lowering the sound output when the modulation signal is high or by raising the sound output when the modulation signal is low.

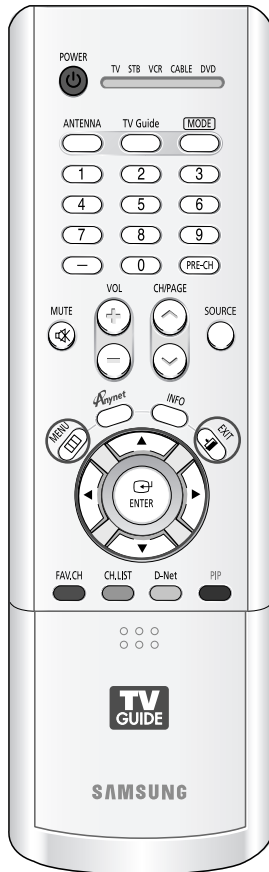

1 Press the MENU button.
Press the ▲ or ▼ button to select "Sound", then press the ENTER button.

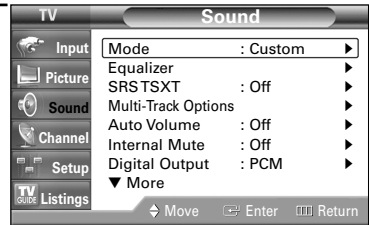

2 Press the ▲ or ▼ button to select "Auto Volume", then press the ENTER button.

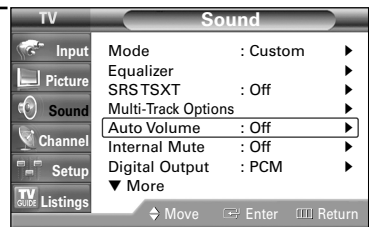

3 Press the ▲ or ▼ button to select "Off" or "On", then press the ENTER button.

Press the EXIT button to exit.

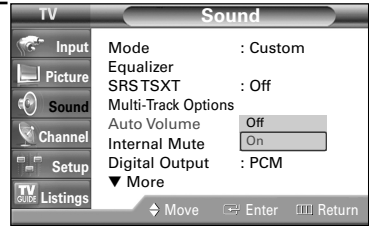

Sound Control

Choosing a Multi-Channel Sound (MTS) track Digital

The digital-TV transmission system is capable of simultaneous transmission of many audio tracks (for example, simultaneous translations of the program into foreign languages). The availability of these additional "multitracks" depends upon the program.



- 1 Press the MENU button.
Press the ▲ or ▼ button to select "Sound", then press the ENTER button.

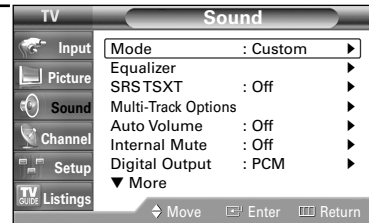

- 2 Press the ▲ or ▼ button to select "Multi-Track Options", then press the ENTER button.

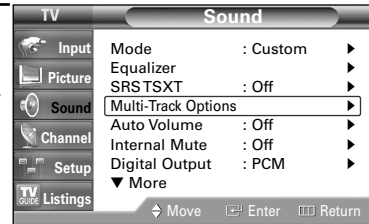

- 3 Press the ENTER button to select "Preferred Language". Press the ▲ or ▼ button to choose the language (English, Spanish or French) you want, then press the ENTER button.

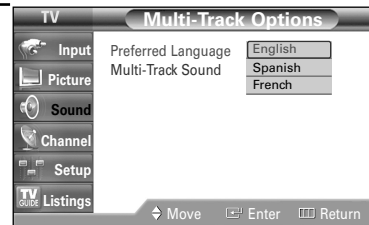

Press the EXIT button to exit.

Alternate method

Press the MTS button on the remote control.
You can listen in a language other than the favorite language by pressing the MTS button.

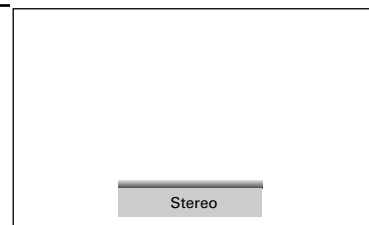

Choosing a Multi-Channel Sound (MTS) track Analog

Depending on the particular program being broadcast, you can listen to Mono, Stereo or SAP.



- 1 Press the MENU button.
Press the ▲ or ▼ button to select "Sound", then press the ENTER button.

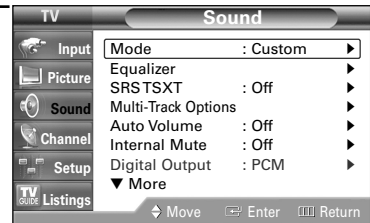

- 2 Press the ▲ or ▼ button to select "Multi-Track Options", then press the ENTER button.

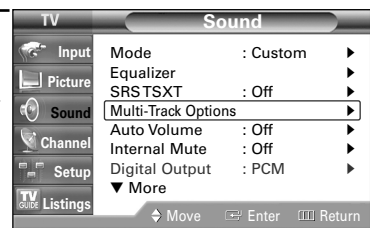

- 3 Press the ▲ or ▼ button to select "Multi-Track Sound", then press the ENTER button.
Press the ▲ or ▼ button to select a setting you want, then press the ENTER button.

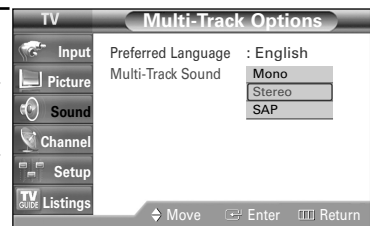

Press the EXIT button to exit.

Alternate method

Press the MTS button on the remote control repeatedly to select an external signal source.

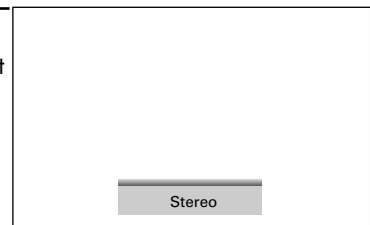

NOTES

- Choose "Mono" for channels that are broadcasting in mono, or if you are having difficulty receiving a stereo signal.
- Choose "Stereo" for channels that are broadcasting in stereo.
- Choose "SAP" to listen to the Separate Audio Program, which is usually a foreign-language translation.

Sound Control

Choosing a Digital Sound Format **Digital**

Digital sound can be output from the rear-panel connector on your TV. The digital sound output is an optical connector labeled "Optical Out". After connecting an optical digital-audio component, you must specify the transmission format (Dolby or PCM, as appropriate to your digital audio component). See the owner's manual of your Digital Audio component for further information.



- 1 Press the MENU button. Press the ▲ or ▼ button to select "Sound", then press the ENTER button.

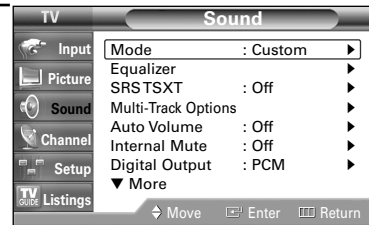

- 2 Press the ▲ or ▼ button to select "Digital Output", then press the ENTER button. Press the ▲ or ▼ button to select "Dolby Digital" or "PCM", then press the ENTER button.

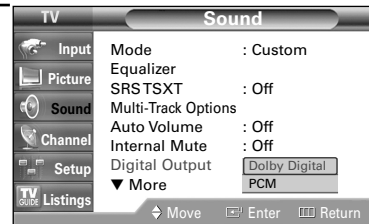

Press the EXIT button to exit.



Manufactured under license from Dolby Laboratories. "Dolby" and the double-D symbol are trademarks of Dolby Laboratories.

Selecting the Internal Mute

When using a device such as a Home Theater or Amplifier with external speakers, you can set Internal Mute to On to cut off sound from the TV's internal speakers.



- 1 Press the MENU button.
Press the ▲ or ▼ button to select "Sound", then press the ENTER button.

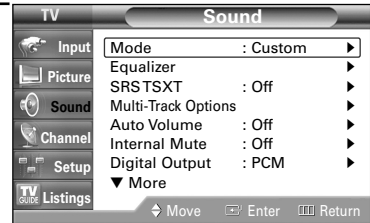

- 2 Press the ▲ or ▼ button to select "Internal Mute", then press the ENTER button.

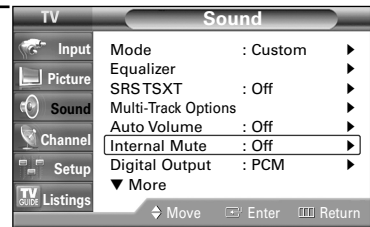

- 3 Press the ▲ or ▼ button to select "On", then press the ENTER button.
Pressing the ▲ or ▼ button will alternate between "On" and "Off".

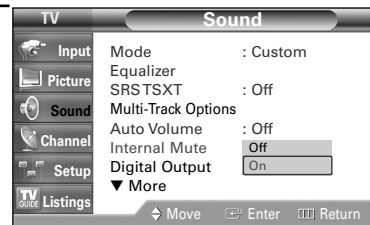

Press the EXIT button to exit.

NOTES

- The VOL +, VOL - and Mute buttons do not operate when the Internal Mute is set to On.
- When Internal Mute is on, only the Multi-Track Options, Melody, Sound Select, and SubWoofer menu are available in the Sound menu.

Sound Control

Setting the On/Off Melody

A melody sound can be set to come on when the TV is powered On or Off.



- 1 Press the MENU button.
Press the ▲ or ▼ button to select "Sound", then press the ENTER button.

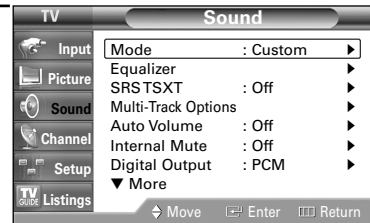

- 2 Press the ▲ or ▼ button to select "Melody", then press the ENTER button.
Press the ▲ or ▼ button to select "On" or "Off", then press the ENTER button.

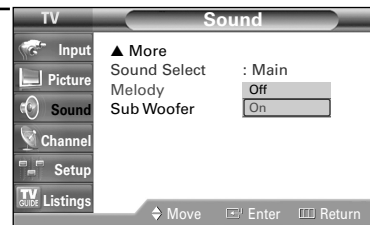

Press the EXIT button to exit.

Setting up the Sub Woofer Output

After connecting a Sub Woofer Speaker (sold separately), you may set the activation, volume and cut-off frequency.



- 1 Press the MENU button.
Press the ▲ or ▼ button to select "Sound", then press the ENTER button.

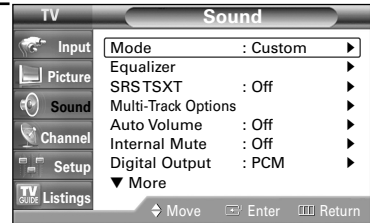

- 2 Press the ▲ or ▼ button to select "Sub Woofer", then press the ENTER button.

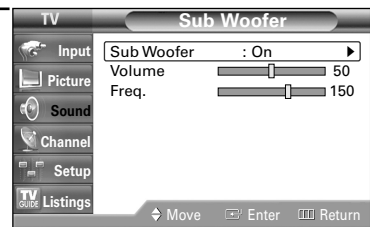

- 3 Press the ENTER button.
Press the ▲ or ▼ button to select "On", then press the ENTER button.
Pressing the ▲ or ▼ button will alternate between "On" and "Off".

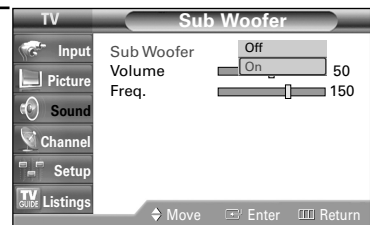

- 4 Press the ▲ or ▼ button to select "Volume" or "Freq.", then press the ◀ or ▶ button to change the value of the item.
 - Volume : adjust the volume of the Sub Woofer.
 - Freq. : adjust the Frequency in units of 10Hz for the best bass response in your room.

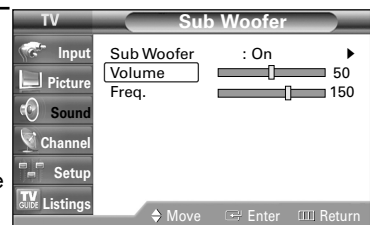

Press the EXIT button to exit.

NOTE

- Refer to page 27 for SubWoofer connection.

SAMSUNG



Special Features



Special Features

Setting the Function Help

Displays Help on the menu functions.

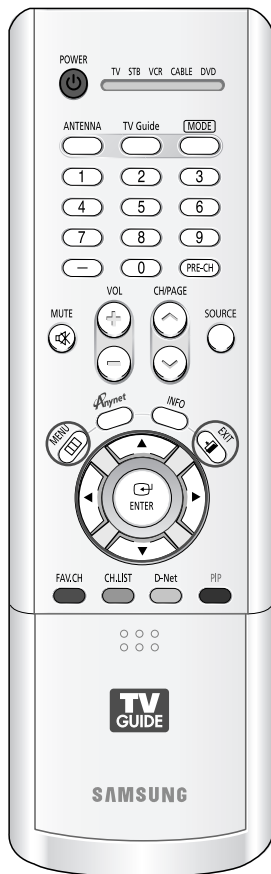

- 1 Press the MENU button.
Press the ▲ or ▼ button to select "Setup", then press the ENTER button.



- 2 Press the ▲ or ▼ button to select "Function Help", then press the ENTER button.

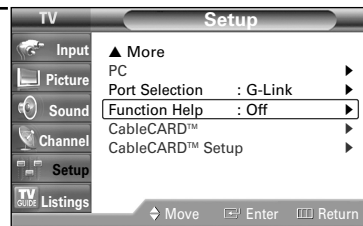

- 3 Press the ▲ or ▼ button to select "On", then press the ENTER button.

Press the EXIT button to exit.

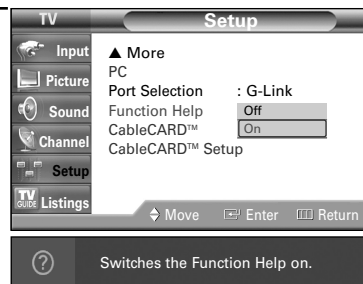

NOTE

- The function Help default setting is ON.

Menu Transparency Level

Adjusts the transparency of the menu screen.



- 1 Press the MENU button.
Press the ▲ or ▼ button to select "Setup", then press the ENTER button.

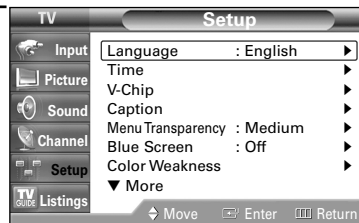

- 2 Press the ▲ or ▼ button to select "Menu Transparency", then press the ENTER button.
Press the ▲ or ▼ button to select level, then press the ENTER button.

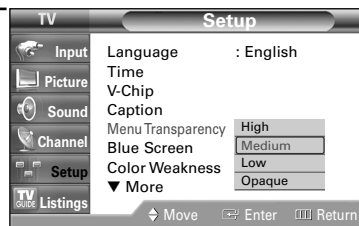

Press the EXIT button to exit.

Special Features

Using the V-Chip

Access to channels and programs is controlled by a password (i.e., a 4-digit secret code that is defined by the user). The on-screen menu will instruct you to assign a password (you can change it later, if necessary).



How to Change Your Password

- 1 Press the MENU button.
Press the ▲ or ▼ button to select "Setup", then press the ENTER button.
Press the ▲ or ▼ button to select "V-Chip", then press the ENTER button.
- 2 Press the number buttons to enter your current 4-digit pin number.
(The default pin number for a new TV set is "0000".)
The "V-Chip" menu is displayed.
- 3 Press the ▲ or ▼ button to select "Change PIN", then press the ENTER button.
- 4 Press the number buttons to enter your new 4-digit pin number.
Re-enter your new pin number to confirm.

Press the EXIT button to exit.

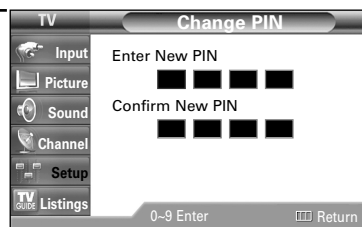
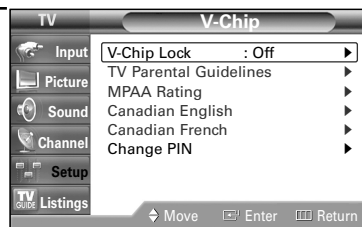
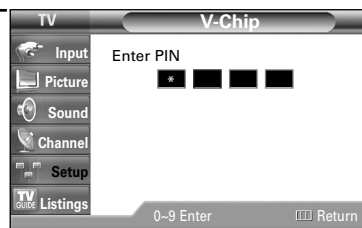
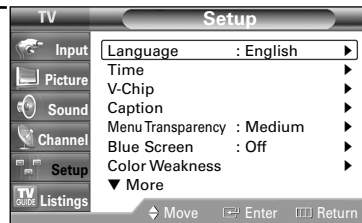

NOTES

- The PIP doesn't function when the V-Chip is active.
- If you forget the pin number, press the remote control buttons in the following sequence, which resets the pin to 0-0-0-0: POWER (Off), MUTE, 8, 2, 4, POWER (On).
- The V-Chip function only works in RF, AV mode and S-Video mode.

How to Enable/Disable the Rating Controls



- 1 Press the MENU button.
Press the ▲ or ▼ button to select "Setup", then press the ENTER button.
Press the ▲ or ▼ button to select "V-Chip", then press the ENTER button.

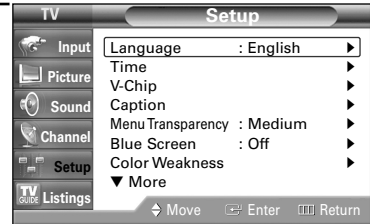

- 2 Press the number buttons to enter your current 4-digit pin number.
(The default pin number for a new TV set is "0000".)
The "V-Chip" menu is displayed.

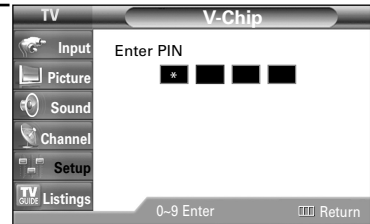

- 3 The "V-Chip" screen will appear. To enable the V-Chip feature, press the ENTER button so that the "V-Chip Lock" field is "On".
(Pressing the ▲ or ▼ button will alternate between "On" and "Off".)
Press the ENTER button.

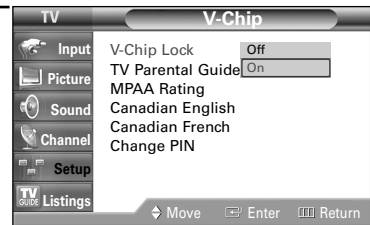

Press the EXIT button to exit.

Special Features

How to Set up Restrictions Using the “TV Parental Guidelines”

The parental restrictions can be set up using either of two methods: The “TV Parental Guidelines” or “MPAA Rating”.



- 1 Press the MENU button.
Press the ▲ or ▼ button to select “Setup”, then press the ENTER button.
Press the ▲ or ▼ button to select “V-Chip”, then press the ENTER button.

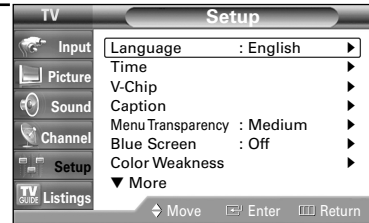

- 2 Press the number buttons to enter your current 4-digit pin number.
(The default pin number for a new TV set is “0000”.)
The “V-Chip” menu is displayed.

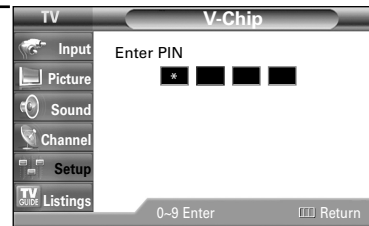

- 3 Press the ▲ or ▼ button to select “TV Parental Guidelines”, then press the ENTER button.



4 You can independently lock the TV ratings. The locked TV (FCC) ratings are indicated by the symbol "🔒". Press the ▲/▼/◀/▶ buttons and the ENTER button to activate the appropriate restrictions for TV (FCC) rating system. To unlock items that are locked, press the Enter button again.

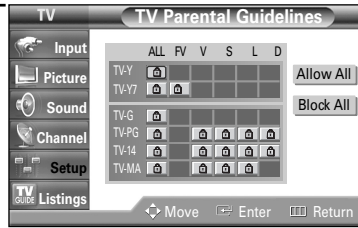

- TV-Y : Young children
- TV-Y7 : Children 7 and over
- TV-G : General audience
- TV-PG : Parent Guidance
- TV-14 : Viewers 14 and over
- TV-MA : Mature Audience

Press the EXIT button to exit.

NOTE

- *Allow All* : Press to unlock all TV ratings.
- *Block All* : Press to lock all TV ratings.

NOTES

- *These categories consist of two separate groups: "TV-Y" and "TV-Y7" (young children through age 7), and "TV-G" through "TV-MA" (everybody else).*
- *The restrictions for these two groups work independently: If a household includes very young children as well as young adults, the TV parental guidelines must be set up separately for each age group. (See page 95.)*

Special Features

How to Set up Restrictions Using the “MPAA Rating”

The Movie rating system uses the “MPAA” (Motion Picture Association of America) system, and its main application is for movies.

When the rating control is on, the TV will automatically block any programs that are coded with objectionable ratings (either “MPAA Rating” or “TV Parental Guidelines”).



- 1 Press the MENU button. Press the ▲ or ▼ button to select “Setup”, then press the ENTER button. Press the ▲ or ▼ button to select “V-Chip”, then press the ENTER button.

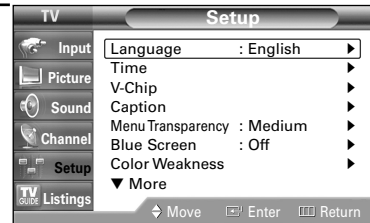

- 2 Press the number buttons to enter your current 4-digit pin number. (The default pin number for a new TV set is “0000”.) The “V-Chip” menu is displayed.

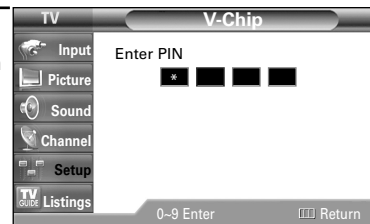

- 3 Press the ▲ or ▼ button to select “MPAA Rating”, then press the ENTER button.

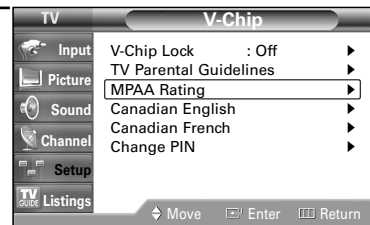

- 4 You can independently lock the movie ratings. The locked movie ratings are indicated by the symbol “🔒”. Press the ▲/▼/ENTER buttons to activate the appropriate restrictions for movie rating system. To unlock items that are locked, press the Enter button again.

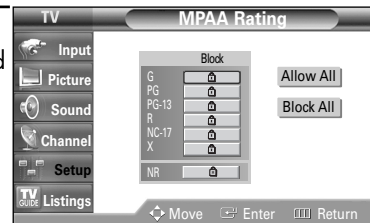

Press the EXIT button.

NOTE

- Allow All : Press to unlock all movie ratings.
- Block All : Press to lock all movie ratings.

Important Notes About Parental Locks

Explanation of the MPAA and TV (FCC) Rating Systems:

TV (FCC) Age-Based Ratings

TV-MA

Mature audiences only. This program may contain mature themes, profane language, graphic violence and explicit sexual content.

TV-14

Parents strongly cautioned. This program may contain sophisticated themes, sexual content, strong language and more intense violence.

TV-PG

Parental guidance suggested. The program may contain infrequent coarse language, limited violence, some suggestive sexual dialog and situations.

TV-G

General audience. It contains little or no violence, no strong language, and little or no sexual dialog or situations.

TV-Y7

Directed to older children. Themes and elements in this program may include mild physical or comedic violence, or may frighten children under the age of seven.

TV-Y

All children. The themes and elements in this program are specifically designed for a very young audience, including children from ages two – six.

TV (FCC) Content Category

V	Violence.
S	Sexual content.
L	Offensive language.
D	Dialog sexual innuendo.
FV	Fantasy or cartoon violence.

MPAA Rating System (Movies)

G	General audience. No restriction.
PG	Children under 13 should be accompanied by an adult.
PG-13	Parental guidance suggested. Children under 13 should be accompanied by an adult.
R	Restricted. Viewers should be 17 or older.
NC-17	Not classified. Viewers should be 17 or older.
X	Adults only.
NR	Not rated.

- TV (FCC) ratings : The particular rating that you have selected will be locked (and indicated as a red "L" on a blue background). Also, all of the age-based ratings will be locked within the particular group (i.e., "group 1" or "group 2"). Suppose that the TV-G rating and all of its contents (V, S, L, and D) are locked. In that case, more restrictive ratings (TV-PG, TV-14, and TV-MA) and all of their contents (V, S, L, and D) are automatically locked as well.
- MPAA ratings : The particular rating that you have selected will be locked. In addition, more restrictive ratings will be locked as well.
- Neither TV (FCC) ratings nor MPAA ratings apply to news programs.

Special Features

How to Set up Restrictions Using Canadian English



- 1 Press the MENU button.
Press the ▲ or ▼ button to select "Setup", then press the ENTER button.

Press the ▲ or ▼ button to select "V-Chip", then press the ENTER button.

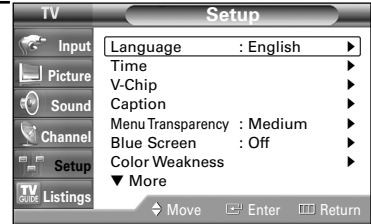

- 2 Press the number buttons to enter your current 4-digit pin number.
(The default pin number for a new TV set is "0000".)
The "V-Chip" menu is displayed.

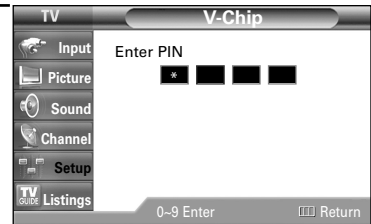

- 3 Press the ▲ or ▼ button to select "Canadian English", then press the ENTER button.

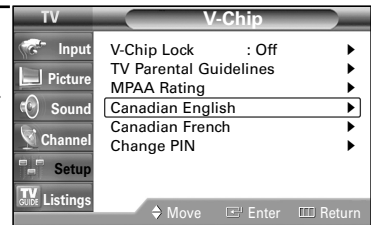

- 4 Press the ▲ or ▼ button to select a appropriate restriction.

Press the ENTER button to activate the restriction selected.
The “🔒” symbol is indicated.
To unlock items that are locked, press the Enter button again.

Press the EXIT button.

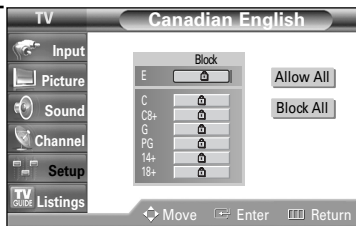

NOTE

- *Allow All* : Press to unlock all TV ratings.
- *Block All* : Press to lock all TV ratings.

E	Exempt programming includes...news, sports, documentaries and other information programming, talk shows, music videos, and variety programming.
C	Programming intended for children under age 8.
C8+	Programming generally considered acceptable for children 8 years and over to watch on their own.
G	General programming, suitable for all audiences.
PG	Parental Guidance.
14+	Programming contains themes or content which may not be suitable for viewers under the age of 14.
18+	Adult programming.

Special Features

How to Set up Restrictions Using Canadian French



- 1 Press the MENU button.
Press the ▲ or ▼ button to select "Setup", then press the ENTER button.

Press the ▲ or ▼ button to select "V-Chip", then press the ENTER button.

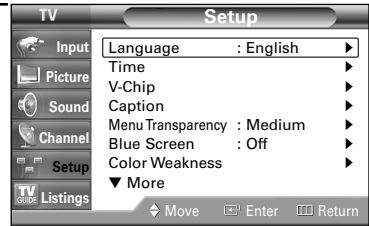

- 2 Press the number buttons to enter your current 4-digit pin number.
(The default pin number for a new TV set is "0000".)
The "V-Chip" menu is displayed.

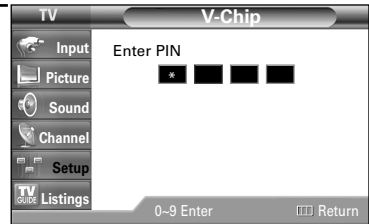

- 3 Press the ▲ or ▼ button to select "Canadian French", then press the ENTER button.

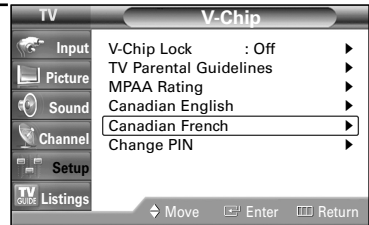

4 Press the ▲ or ▼ button to select a appropriate restriction.

Press the ENTER button to activate the restriction selected.
The "🔒" symbol is indicated.
To unlock items that are locked, press the Enter button again.

Press the EXIT button.

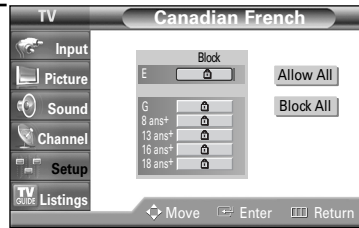

NOTE

- *Allow All* : Press to unlock all TV ratings.
- *Block All* : Press to lock all TV ratings.

- E** Exempt programming includes...news, sports, documentaries and other information programming, talk shows, music videos, and variety programming.
- G** General.
- 8 ans+** 8+ General-Not recommended for young children.
- 13 ans+** Programming may not be suitable for children under the age of 13.
- 16 ans+** Programming is not suitable for children under the age of 16.
- 18 ans+** Programming restricted to adults.

Special Features

Viewing Closed Captions (On-Screen Text Messages) **Analog**

The Analog Caption function operates in either analog RF channel mode or external source mode. (Depending on the broadcasting signal, the Analog Caption function may operate on digital channels.)



- 1 Press the MENU button.
Press the ▲ or ▼ button to select "Setup", then press the ENTER button.

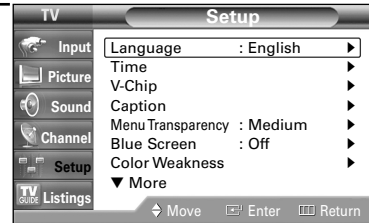

- 2 Press the ▲ or ▼ button to select "Caption", then press the ENTER button.

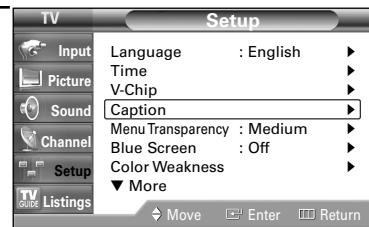

- 3 Press the ENTER button to select "Caption".

Press the ▲ or ▼ button to select "On", then press the ENTER button.

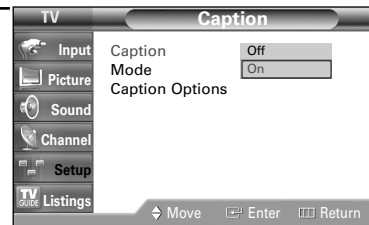

- 4 Press the ▲ or ▼ button to select “Mode”, then press the ENTER button. Press the ▲ or ▼ button to select submenu (CC1~CC4 or Text1~Text4) you want, then press the ENTER button.

Press the EXIT button to exit.

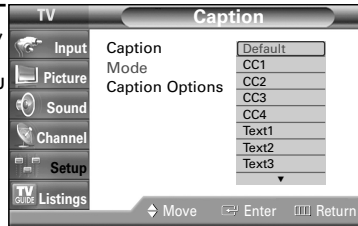

NOTES

- The default is “CC1”.
 - CC1 : The Primary Synchronous Caption Service. These are captions in the primary language that must be in sync with the sound, preferably matched to a specific frame.
 - CC2 : The Special NonSynchronous Use Captions. This channel carries data that is intended to augment information carried in the program.
 - CC3 : Secondary Synchronous Caption Service. Alternate program-related caption data, typically second language captions.
 - CC4 : Special Non-Synchronous Use Captions. Similar to CC2.
 - Text1 : First Text Service. This may be various non-program related data.
 - Text2 : Second Text Service. Additional data, usually not program related.
 - Text3/Text4 : Third and Fourth Text Services. These data channels should be used only if Text1 and Text2 are not sufficient.
- The Caption feature only works in RF, AV and S-Video mode.
- The availability of captions depends on the program being broadcast.

Special Features

Viewing Closed Captions (On-Screen Text Messages) Digital

The Digital Captions function operates on digital channels.



NOTE

- "Caption Options" are available only when "Service 1 ~ Service 6" can be selected in "Mode".

- 1 Press the MENU button. Press the ▲ or ▼ button to select "Setup", then press the ENTER button.

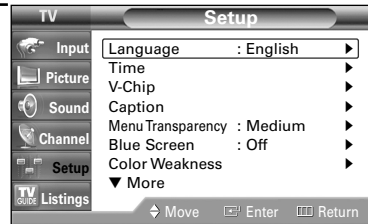

- 2 Press the ▲ or ▼ button to select "Caption", then press the ENTER button.

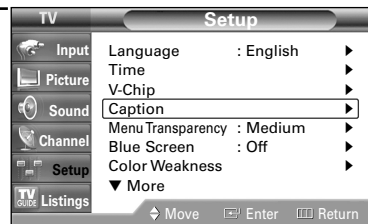

- 3 Press the ENTER button to select "Caption".

Press the ▲ or ▼ button to select "On", then press the ENTER button.

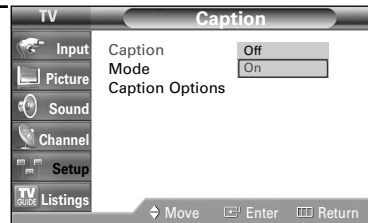

- 4 Press the ▲ or ▼ button to select "Mode", then press the ENTER button. Press the ▲ or ▼ button to select submenu (Service 1 ~ Service 6, CC1~CC4 or Text 1 ~ Text 4) you want, then press the ENTER button.

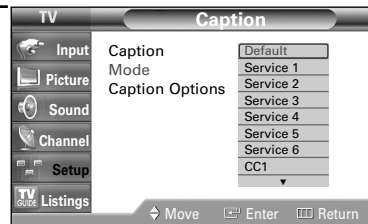

- 5 Press the ▲ or ▼ button to select "Caption Options", then press the ENTER button.

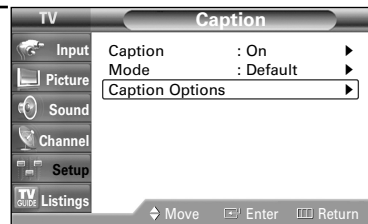

- 6 Press the ▲ or ▼ button to select "Size", then press the ENTER button.
 Press the ▲ or ▼ button to select the desired item in the Size menu, then press the ENTER button.
 Set other listed options below using the same method as above.
 Press the EXIT button to exit.

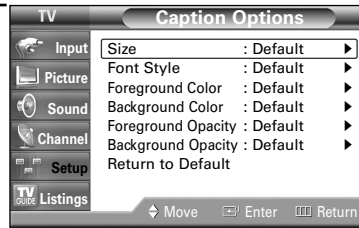

NOTE

- The availability of captions depends on the program being broadcast.
- "Default" means to return to the original caption options set by the broadcaster.

Size

This option consists of "Default", "Small", "Standard", and "Large". The default is "Standard".

Font Style

This option consists of "Default", "Style0 ~ Style 7". You can change the font you want. The default is "Style 0".

Foreground Color

This option consists of "Default", "White", "Black", "Red", "Green", "Blue", "Yellow", "Magenta", and "Cyan". You can change the color of the letter. The default is "White".

Background Color

This option consists of "Default", "White", "Black", "Red", "Green", "Blue", "Yellow", "Magenta", and "Cyan". You can change the background color of the caption. The default is "Black".

Foreground Opacity

This option consists of "Default", "Transparent", "Translucent", "Solid", and "Flashing". You can change the opacity of the letter.

Background Opacity

This option consists of "Default", "Transparent", "Translucent", "Solid", and "Flashing". You can change the background opacity of the caption.

Return to Default

This option sets each of "Size", "Font Style", "Foreground Color", "Background Color", "Foreground Opacity", and "Background Opacity" Color to its default.

Alternate method

Press the CAPTION button on the remote control repeatedly to select "On" or "Off".

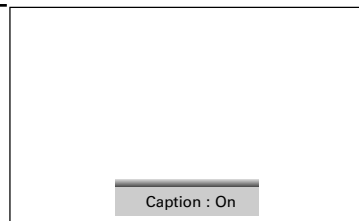

Special Features

Setting the Port Selection Mode

Sets your port selection mode to Anynet, G-Link or RS232C.

The Anynet functions, the G-LINK™ and the RS232C functions of external devices cannot be operated at the same time. Use this menu to set your port selection mode.



- 1 Press the MENU button.
Press the ▲ or ▼ button to select "Setup", then press the ENTER button.



- 2 Press the ▲ or ▼ button to select "Port Selection", then press the ENTER button.

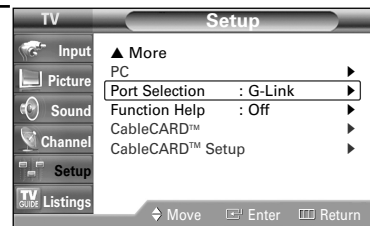

- 3 Press the ▲ or ▼ button to select "Anynet", "G-Link" or "RS232C", then press the ENTER button.

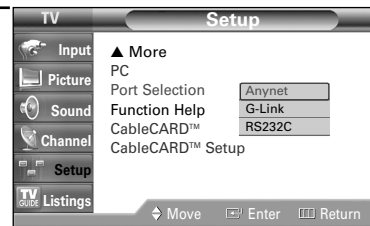

Press the EXIT button to exit.

NOTES

- The default setting for the port selection mode is "G-Link".
- Select the "G-Link" to operate an external device after connecting the IR Controller cable to the G-LINK™ terminal.
(Refer to the TV Guide On Screen™ manual and TV Guide On Screen™ Quick Setup Sheet for further information on G-LINK™.)
If you set the port selection mode to G-LINK™, Anynet and RS232C functions are not available.
- To download program listings, the TV Guide On Screen™ system needs to be able to change channels on your cable box when the TV is not in use. Please connect the supplied G-LINK™ cable to the G-LINK™ jack of the TV. After you connect the G-LINK™ cable you will be able to control your cable box using the TV's remote.
- To use Anynet or RS232C Function, set your port selection mode back to "Anynet" or "RS232C".
- For further information on Anynet's functions, refer to the "Anynet" manual.
- For further information on RS232C, refer to the "PROCEDURES FOR CONTROLLING A DLP DTV USING AN RS-232C CONNECTION" manual.

Using the CableCARD

This menu works with a CableCARD provided by a local cable service provider.

Prior to accessing this menu, a CableCARD should be connected to the rear panel of the TV.

For detailed connection instructions, refer to the "Connecting CableCARD" section on page 21 of this manual.

Displaying CableCARD related information

To access information on Status, Pairing, Network Setup of the CableCARD provided by the service provider in CableCARD menu.

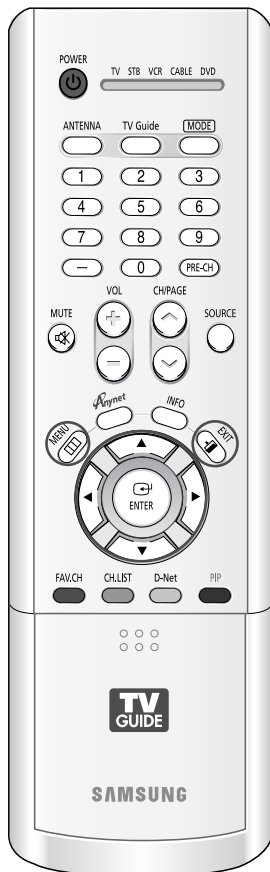

- 1 Press the MENU button.
Press the ▲ or ▼ button to select "Setup", then press the ENTER button.

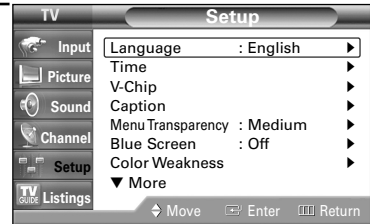

- 2 Press the ▲ or ▼ button to select "CableCARD™", then press the ENTER button.

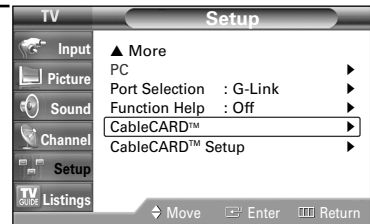

- 3 Press the EXIT button to exit.

Special Features

Using the CableCARD Setup Function

Sets up relevant CableCARD options.

CableCARD Reset

Resets CableCARD when the channels provided by CableCARD are not available.



- 1 Press the MENU button.
Press the ▲ or ▼ button to select "Setup", then press the ENTER button.

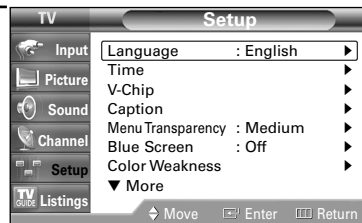

- 2 Press the ▲ or ▼ button to select "CableCARD™ Setup", then press the ENTER button.

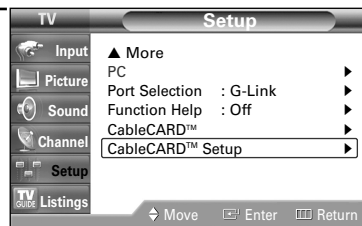

- 3 Press the ENTER button to select "CableCARD™ Reset".

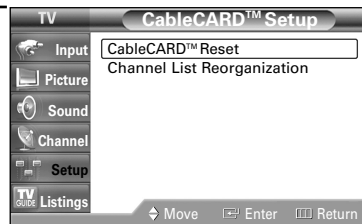

Channel List Reorganization

Deletes and reorganizes the channel list provided by CableCARD.

This feature should be used if you change or upgrade your CableCARD service.



- 1 Press the MENU button.
Press the ▲ or ▼ button to select "Setup", then press the ENTER button.

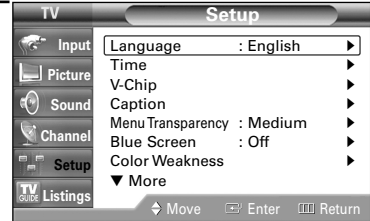

- 2 Press the ▲ or ▼ button to select "CableCARD™ Setup", then press the ENTER button.

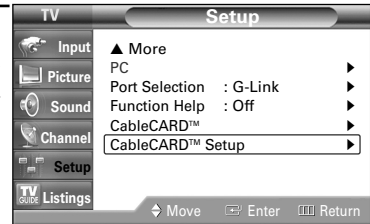

- 3 Press the ENTER button to select "Channel List Reorganization".

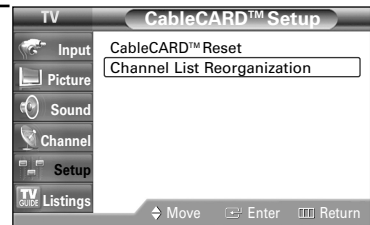

Special Features

Using Game Mode

When connecting to a game console such as PlayStation™ or Xbox™, you can enjoy a more realistic gaming experience by selecting Game mode.



1 Press the MENU button. Press the ENTER button to select "Input".

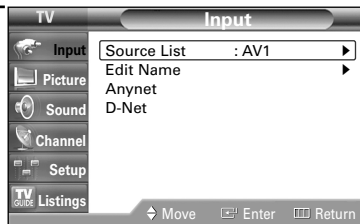

2 Press the ▲ or ▼ button to select "Edit Name", then press the ENTER button.

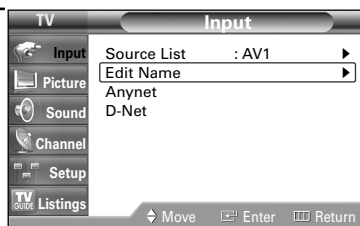

3 Press the ▲ or ▼ button to select a signal source to edit, then press the ENTER button.

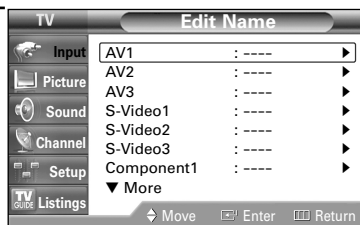

4 Press the ▲ or ▼ button to select "GAME", then press the ENTER button.
Press the EXIT button to exit.

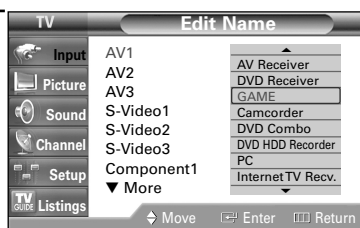

NOTES

- Game mode is only available for AV1, AV2, AV3, S-Video1, S-Video2, S-Video3, Component1 and Component2.
- For Component input, Game mode only supports a resolution of 480i.
- Since selecting Anynet cancels Game mode, to play a game, select Game mode again.
- You cannot rename an input port to which an Anynet device is connected after setting Anynet.
- To set the game mode of the input port (Composite/S-Video/Component), set Anynet again after connecting a game console.

Restrictions on Game Mode (Caution)

- To Disconnect the game console and connect another external device, cancel Game mode in the Edit name menu.
- If you display the TV menu in Game mode, the screen shakes slightly.
- In Game mode, the TV Guide On Screen™ Reminder function does not work.

Disabled Menus in Game Mode

In Game mode, you will not be able to use some items in the Input, Picture, Sound, Channel, Setup and Listings menus.

1. Input: Anynet and D-Net are disabled.
2. Picture: All functions are disabled except for the Contrast, Brightness and the Reset function of the P.Mode
3. Sound: Sound Select is disabled when Game mode is selected (because PIP is disabled)
4. Channel: (Disabled regardless of Game mode)
5. Setup: Disabled when Game mode is selected - Caption, ColorWeakness, Menu Transparency, Function Help
6. Listings: (Disabled regardless of the Game mode selection)

Using TV Guide On Screen™

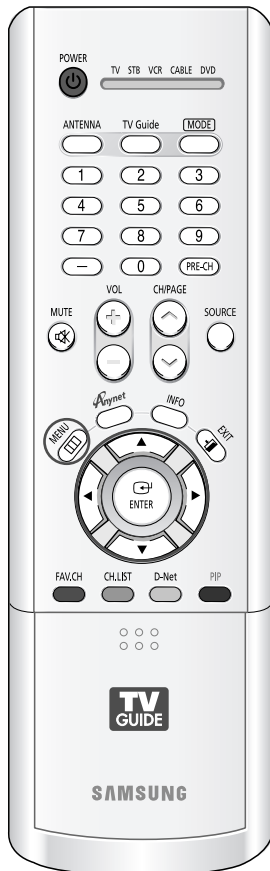

1 Press the MENU button. Press the ▲ or ▼ button to select "Listings", then press the ENTER button.

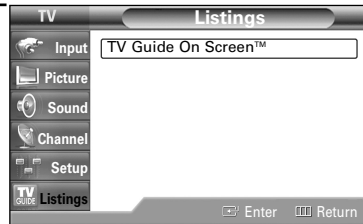

2 Press the ENTER button to select "TV Guide On Screen™".

- If you decide not to setup the Guide now, this reminder screen will appear each time you power On the TV (except if you selected "Don't remind me again").



Press the EXIT button to exit.

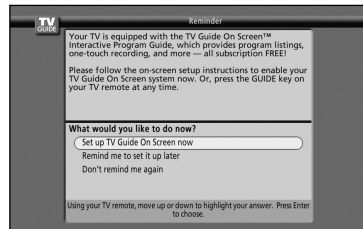

NOTES

- In order for the Guide to receive channel lineup & listings successfully, "Auto Program" must be performed at least once, prior to powering off your TV. The Guide displays the channels that are programmed during "Auto Program".
- Refer to TV Guide On Screen™ manual for details.

SAMSUNG



Using the D-Net

Using the D-Net

What's D-Net?

This refers to a home network consisting of devices supporting D-Net (IEEE1394) connections (such as digital VCRs and Set-Top Boxes) for digital audio and video data.

The D-Net (IEEE1394) standard for the High Performance Serial Bus is a serial data transfer protocol and interconnection system.

D-Net (IEEE1394) interface is capable of supporting various high-end digital A/V applications, such as A/V device control and signal routing, Digital Video (DV) editing, home networking.

How to connect compatible IEEE1394 Devices

Connecting compatible IEEE1394 devices is simple using this TV equipped with IEEE1394. A secure digital interface is provided to other digital home entertainment units, such as a DTV, a Set-Top Box, an AVHDD, a digital VCR, a MPEG Camcorder.

1 Connect the IEEE1394 cable from the jack of the component with IEEE1394 capability, such as a Set-Top Box or a Digital VCR to the IEEE1394 jack on the TV.

2 Press the D-Net button on the Remote Control.

3 Select the D-Net (IEEE1394) Compatible device.

NOTES

- To access D-Net (IEEE1394) in the menu, see page 117.
- The IEEE1394 interface is equipped with a copy protection standard called Digital Transmission Content Protection (DTCP).
- The name of 1394 Jack may be different according to the manufacturer (i.e., DTV LINK or i.LINK).
- The supported video format is MPEG-2 Digital video. Other digital video formats (e.g. DV format...) are not supported.
For audio, Dolby Digital and MPEG Digital Audio are supported, other digital audio formats (e.g. MP3, DTS) are not supported.
- Because IEEE1394 is an evolving technology, it is possible that some or all of the connectivity features of a device you connect to the TV through the IEEE1394 port may not operate.
- There may be a single IEEE1394 jack depending on the specifications of the external device.
- If only a single IEEE1394 jack is supported, connect the cable to the last jack.

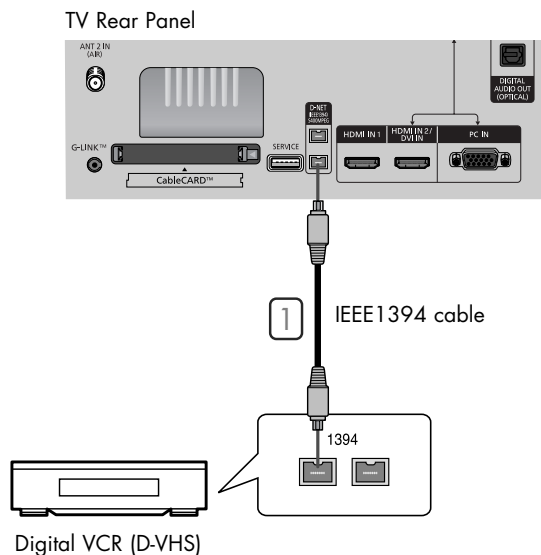

When Connecting D-Net (IEEE1394) Compatible devices

- 1 The last device in the chain may not be looped back to the TV as the TV may not be able to work with the other devices.
To connect two or more D-Net (IEEE1394) Compatible devices, follow the diagram below.

A maximum 10 D-Net (IEEE1394) Compatible devices can be connected.

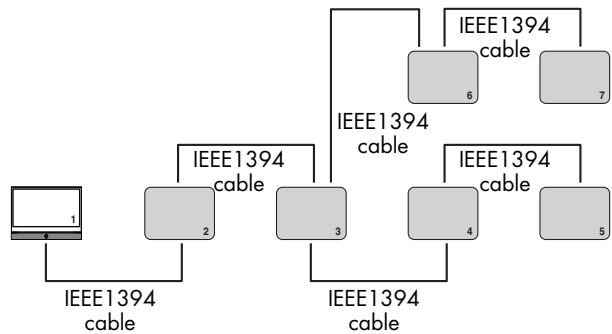
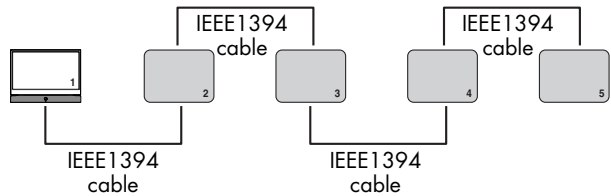

Do not connect D-Net (IEEE1394) Compatible devices in a way that creates a loop.

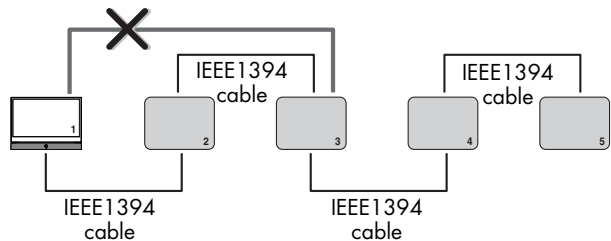

NOTE

- IEEE1394 cables longer than 14.76 feet (177.16 inches) should not be used between devices.

Using the D-Net

Connection Options

There are two different connection options for connecting D-Net (IEEE1394) compatible devices. Select the most suitable option according to your network of audio/video products.

The Direct Device-To-Device Option

D-Net (IEEE1394) permits the chaining of devices, unlike analog audio and video connections where each device needs to be individually connected to the TV. This allows you to connect your D-VHS to your 1394 Set-Top Box only, then connect the Set-Top Box to the TV.

More IEEE1394 devices can be added to the chain as needed. Each video device can be viewed on the TV's D-Net and information can be sent from any IEEE1394 device to other compatible devices.

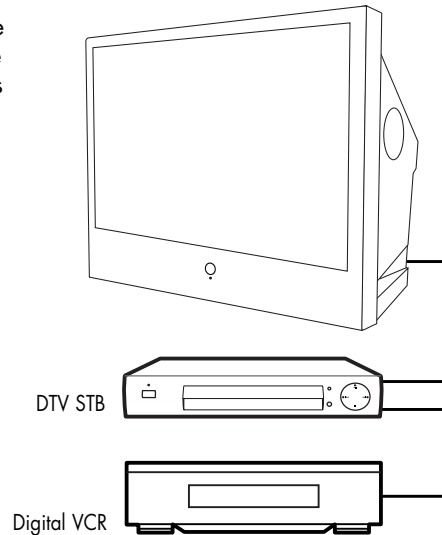

The Hub Connection Option

D-Net (IEEE1394) also permits connecting devices using the TV as a hub. Each device is capable of sending information, which may include audio and video, to any other device on the network.

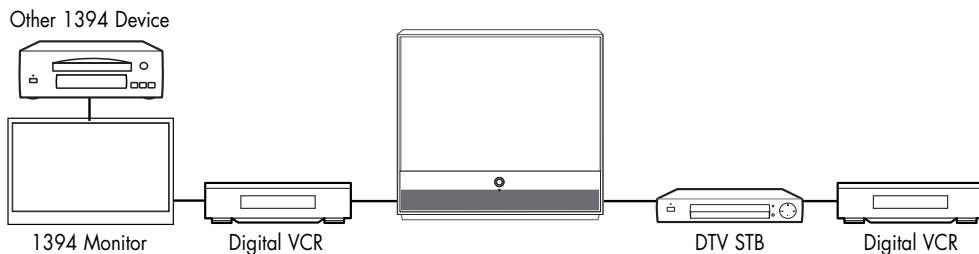

4-Pin and 6-Pin Connectors

Two different types of connectors are used for IEEE1394 terminals and cables, a 4-pin and a 6-pin.

The 4-pin connector sends digital audio, digital video and digital control signals to and from devices. The TV has two available 4-pin connection jacks, of which two are at the back.

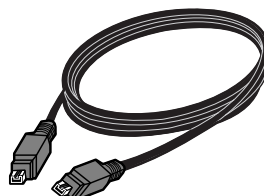

The 6-pin connector also sends digital audio, video and control signals, but can also send low voltage electrical power. There are no 6 pin connectors on this TV.

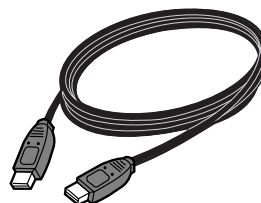

It is not possible to directly connect a 6-pin connector to a 4-pin jack, and vice versa. In order to connect a 6-pin device to a 4-pin device, an adaptor or adaptor cable is required, easily purchased from an electronic or computer store.

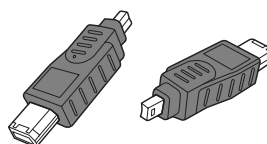

Connecting a 6-pin device (such as a camcorder) directly to the TV, (if it is designed to receive electrical power from another 6-pin device) will require that the camcorder is directly connected to the AC supply, or that the camcorder's battery power is used.

Using the D-Net

Selecting a D-Net device

Prior to viewing an IEEE1394 device, it first needs to be selected in the D-Net Device List.

- 1 Connect the relevant D-Net (IEEE 1394) Compatible device in the list.
(See "How to connect compatible IEEE1394 Devices" on page 112)

- 2 Press the D-Net button on the remote control.

- The TV and all other devices connected on the D-Net (IEEE1394) chain appear in the D-Net device list.
- If "UNCONTROLLABLE" is listed in the device list, the device is not supported by the TV, and cannot be controlled with the TV remote control or the D-Net control panel on the screen.
- The device list is in the order of DTV, STB, AVHDD, DVHS, Camcorder and UNCONTROLLABLE. If there are multiple devices of the same type, the devices will be listed in ascending order of the manufacturer name with Samsung first as the exception. If there are multiple devices of the same type and they are manufactured by the same company, they will be listed in the order of their serial number.



- 3 Select a connected D-Net device by pressing the ▲ or ▼ button.

- It is possible to connect a D-Net device to another device and to the TV while the TV is ON. The D-Net device list automatically adds the newly-connected device to the list. See "How to connect compatible IEEE1394 Devices", page 112 on connecting D-Net (IEEE 1394) Compatible devices.



- 4 To select a device, press the ENTER button. Then display the D-Net device control panel and operate the selected device.

- At this time, the screen changes to the picture from the selected device.



Follow the instructions below to activate D-Net in the menu.

- 1 Press the MENU button.
Press the ENTER button to select "Input".

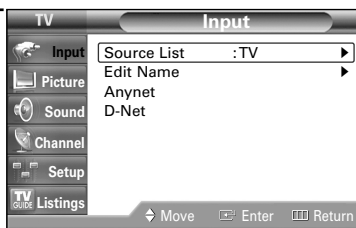

- 2 Press the ▲ or ▼ button to select "D-Net", then press the ENTER button.

- The TV and all other devices, connected on the D-Net (IEEE1394) chain, appear in the D-Net device list.
- This is also available using the D-Net button on the remote control.

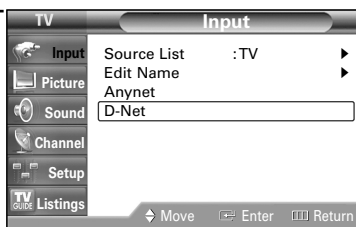

- 3 Press the ▲ or ▼ button to select a D-Net (IEEE1394) connected device.

Using the D-Net

The D-Net control panel

Select an IEEE1394 from the D-Net device list. The TV will then display the D-Net control panel. This panel allows you to use the TV remote control to control the selected IEEE1394 device.

1 Press the D-Net button on the remote control.

2 Press the ▲ or ▼ button to select a D-Net (IEEE1394) connected device. Press the ENTER button.

- The D-Net control panel appears on the bottom of the screen.



3 Use the ▲, ▼, ◀, ▶ buttons on the remote control to move through the options (see next page) available in the D-Net control panel.

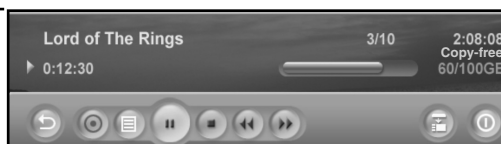

4 Press the ENTER button to select an option.













5 To view the IEEE1394 device in FULL SCREEN, press the EXIT button on the remote control.

- To exit D-Net mode, select DTV from the D-Net device list or press the SOURCE button on the remote control.

NOTE

- For information about how to use the icons, refer to the following page.

Control Panel ()

Button	Name	To do this
	Return	Move to the previous menu.
	Target	Start and stop recording a Digital stream.
	Program List	Display the AVHDD program list.
	Play	Play the digital stream from the selected digital device.
	Stop	Stop the digital stream from the selected digital device.
	Rewind	Fast rewind a digital stream from the selected digital device.
	Forward	Fast forward a digital stream from the selected digital device.
	Device menu	Display the EIA-775 OSD receive to connected 1394 device. Display only EIA-775 support device.
	Power	Turn the Power of the selected device ON/OFF.
	Go to recording position	When in time shift mode on AVHDD, this moves to the recording position.
	Recording	Display only Camcoder recordings.
	Pause	Pause Play.
	Recording stop	Display only AVHDD recordings.

NOTES

- Press the ▲, ▼, ◀, ▶ buttons on the remote control to select a control panel button and press the ENTER button on the remote control.
- Depending on the device being controlled, not all options on the D-Net control panel may be available.
- The selected IEEE1394 device and its functions can be controlled through the equivalent buttons on the TV's remote control.
- Not all functions are supported for all IEEE1394 devices.
- It is possible to use direct keys on the remote control (rewind, stop, play/pause, fast forward) to control external devices.

* **What is EIA-775** : EIA-775 is an OSD standard that enables the control of external 1394 devices using functions such as Play, Stop, etc.

* **What is CEA-931** : This is a standard for controlling external IEEE1394 devices with the TV remote control and not the remote control of the external device.

For example, to play DVHS, you press the Play button of the TV instead of the Play button of the DVHS, the Play command is transmitted to the DVHA through the IEEE1394 connection.

Operating Tips

- 1) When the screen is switched to the TV program.
 - When you select the first button, the TV button, in the Device List, it switches to the TV program.
 - Although you have selected another device from the Device List, if detecting a video signal from the device fails, the "Connection failed" message appears and the screen automatically switches to the TV program.
 - When the 1394 connection to the selected device is disconnected, the screen automatically switches to the TV program. If you reconnect the device, the reconnected device is automatically selected.
- 2) AVHDD, DVHS and camcorders automatically stop when you select another device while watching one of the devices.
- 3) Some devices may be displayed in the Device List as 'UNCONTROLLABLE'.
This may happen when the device does not contain the proper information or it cannot read.
- 4) Some devices may not be recognized and may be disconnected from the 1394 connection when they are turned off.
- 5) When connecting another TV, the TV may transmit *Digital TS which appears in the TV or another picture (e.g. Only RF may be transmitted, although DVHS is being displayed on the screen) depending on the TV specifications.

* **What is Digital TS** : DTV packages digital data (video, audio and data) into 188 byte units using the MPEG-2 algorithm and transmits the data unit unlike for analog. It is called Digital Transport Stream or Digital TS.
- 6) When connected to another STB, some STBs may not be displayed in the Device List due to device specifications or defects when multiple devices are connected.
Even if the device is displayed in the Device List, the connection to the device may fail. Otherwise, due to STB trouble, the video stream may be stopped while recording, or the recording may fail. In this case, you have to discover which device is defective by removing the devices one by one.
- 7) When connected to the AVHDD
 - To rotate the AVHDD disc, there may a time delay.
 - Some AVHDDs may provide two playbacks or recordings simultaneously. In this case, there may be two Play icons in the Program List and 2 AVHDD buttons in the Target List.
 - If you copy a program from the Program List, the selected AVHDD program is played on the TV screen and recorded using the device selected from the Target List.
Even if the program reaches its end, the recording device does not stop automatically.
 - Some AVHDDs may display the wrong program information after recording, depending on the situation.
 - If AVHDD is recording, the program is automatically played which is currently being recorded, when it is selected from the Device List. (PVR function)
 - For the "Go to recording position" button operation, the difference between recording and play time must be longer than 30 seconds.
- 8) When connected to DVHS
 - Some devices support an automatic connect function (I-mode). These devices may cause a malfunction when multiple devices are connected.
 - Some DVHS devices may not record properly when multiple devices are connected and the mode is I-mode.
- 9) When connected to a camcorder
 - Depending on if the camcorder is in Tape or Camera Mode, the control panel changes.
If the camcorder turns off the power (power saving mode), the camcorder may disappear from the Device List.

- 10) When multiple devices are connected, some devices may appear and then disappear periodically in the Device List. This is because some devices malfunction when multiple devices are connected.

If this occurs, you have to discover and remove the defective device from the connection by removing the devices one by one.

- 11) When multiple devices are connected, the response time may be relatively long when selecting a device. This may happen when there is a device(s) that malfunctions and degrades the 1394 connection speed.

At this time, some of the functions of AVHDD or DVHS may not work, and the stream connection may fail. If this occurs, you have to discover and remove the defective device from the connection by removing the devices one by one.

- 12) Copy Protection

- You can record a Copy-Free, or Copy-One-Generation screen.
- Although you cannot record a Copy-No-More, or Copy-Never screen, you can view it through another device.
- If you change the channel to a 'copy never' channel while recording a 'copy free' channel, the recording is automatically stopped in some devices. Even if the program was recorded, you will not be able to view the recorded 'copy never' channel. At this time, therefore, the user has to manually stop the recording.

Copy information

Message	Descriptions
Copy_free	Able to copy.
No_more_copies	Unable to copy anymore.
Copy_one_generation	Able to copy once.
Copy_never	Unable to copy.

- 13) When multiple devices are connected, and a device malfunctions while playing DVHS or AVHDD, the user may experience interrupted screen play.

- 14) When playing and recording a program simultaneously using AVHDD, and the program is copy protected, the program may not play depending on whether the AVHDD device supports simultaneous copy protection.

- 15) When AVHDD or DVHS is being played, and you press the Pause button, some products may show the "No Signal or Weak Signal" message on the TV screen instead of a still picture as there is no video stream from the product.

- 16) If the number of connected IEEE 1394 devices exceeds 10, it may cause abnormal operation.

- Yes and Play may not operate smoothly, if you play after recording.
- Yes and the Play, Record and Copy functions do not work properly.
- Disconnect the malfunctioning device and then try again.

Recording Tips

- 1) Recording using the Target List while also watching the screen being recorded.
 - Check that the AVHDD and DVHS devices are connected.
 - Select a source device to be recorded and press the Target button.
 - Select a device to be recorded from the Target List.
- 2) Recording a program in the Program List of AVHDD using another device.
 - Select an AVHDD program to be recorded from the Program List and press Copy.
 - Select the target device from the Target List.

NOTES

- *In this case, the selected program is automatically played and displayed on the TV screen and the target device automatically starts recording.*
- *Controlling a device with another device's remote control or through manual operation, may cause a malfunction when controlling a device through the TV. When copying a program, the recording will not stop automatically when the program reaches its end.*
- *Although you can make a recording to connected devices regardless of copy protection, you may not be able to watch the copy-protected recording as the playback picture may be distorted.*
- *When recording an HD program on cable TV or from satellite, programs on some channels may not be recorded if the program exceeds the limit of the allowable range of recording devices such as D-VHS.*
- *If a recording is in process and another command is issued while the "Recording..." D-Net Notice is displayed on the screen, the recording may fail.*

Tips on stopping recording

- 1) In general, you can instantly evaluate the current recording device through the Target List. If you select a device that you wish to stop, a message appears asking if you really want to stop recording.
- 2) For DVHS. If you select a recording DVHS from the Device List, a message appears asking if you really want to stop recording.
- 3) For AVHDD, if the program currently being recorded is selected, you can stop the recording using the Recording stop button.

NOTE

- *Controlling a device through another device or through a manual operation may cause a malfunction when controlling a device through the TV.*

Troubleshooting (D-Net)

Problem	Possible Solution
<p>The device is displayed as being "UNCONTROLLABLE".</p>	<p>Only DTVs, STBs, AVHDDs, DVHSs and MPEG camcorder IEEE 1394 devices are controllable. Other devices will display "UNCONTROLLABLE" in the device list.</p> <p>Some supported devices may display as "UNCONTROLLABLE" due to an initialization error.</p> <p>→ If a device is supported but is displayed as "UNCONTROLLABLE", reconnect the 1394 cable. If this does not work, this is because the information about the device is unreadable due to an internal error.</p>
<p>A connected device is not displayed in the device list.</p>	<p>A device, which has experienced an error during initialization, may malfunction and affect the operation of other connected devices. Other devices may not be displayed in the list.</p> <p>→ Disconnect and reconnect the 1394 cable.</p> <p>→ Remove a device which does not guarantee compatibility when multiple devices are connected.</p>
<p>"Check the connection with IEEE 1394 cable." message appears.</p>	<p>This message appears when there is a problem with the connected device or the 1394 cable. Initialization might fail when multiple devices are connected due to limitations of some connected devices.</p> <p>→ Check that the 1394 cable is making a loop and reconnect the 1394 cable.</p> <p>Check that cables are correctly connected to all connected devices.</p> <p>This message may appear due to an operating error of the 1394 port of a particular device.</p>
<p>"Connection is failed. Exceeds the limit of 1394 network connection." message appears.</p>	<p>IEEE 1394 supports a limited number of screen connections. This message appears when the limit has been exceeded.</p> <p>→ Stop unnecessary operations such as playing, recording, etc. and try it again.</p> <p>Turn the auto screen connection function (I-mode) of DVHS devices OFF, and retry.</p> <p>If a camcorder is connected and it is not currently being used, turn it off or disconnect it from the 1394 network.</p>

Continued...

Using the D-Net

Problem

"Connection is failed.
1394 network speed is not
compatible." message appears.

Possible Solution

This message appears when the connection speed of the connected device and the device selected from the Target List are different when copying data.

→ Connect a low speed device between the two devices. (See figure)

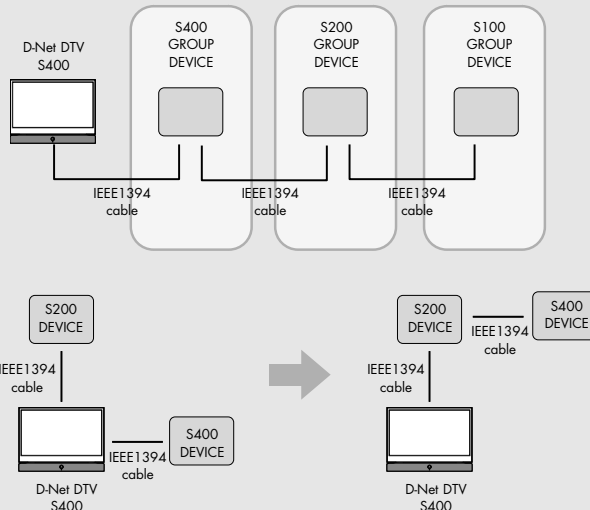

※ A 1394 device has a maximum connection speed which will be marked near the IEEE 1394 connector with an "S" number (i.e., S100,S200,S400). The higher the number, the faster the maximum connection speed. This TV has a maximum connection speed of S400.

"This device is occupied by another device." message appears.

This message appears when you try to record a device, which is currently being recorded manually or by another device, through the TV.

→ Stop the recording device and retry.

"Authentication is failed" message appears.

Check that the connected device supports DTCP.

"Recording is prevented." message appears.

This message appears when trying to copy protected content.

Although DV Camcorder is in the device list, no picture is displayed on the screen when the DV camcorder is selected.

Although a camcorder which supports the DV format appears in the device list, you cannot watch video from the camcorder even if you select the camcorder as an input source, because the TV supports the MPEG format only.

Continued...

Problem	Possible Solution
No picture on the screen after selecting a device	Check if the current mode for DTV and STB is set to analog by mistake. For AVHDD, check if the played content reaches to the end. (Select the item from the content list again.) For DVHS, check if a D-VHS tape is being used. If the camcorder supports the DV format, no picture will be displayed on the screen.
"Initializing D-Net" message appears.	This message appears when the D-Net function is being initialized. Retry after a short wait to use the D-Net function.
"Exceeds the limit of device numbers." message appears.	This message appears when the number of currently connected D-Net devices exceeds 10. Retry after disconnecting unnecessary devices.
"Recordable device is not connected" message appears.	This message appears when the recordable device is not on the network when you try to make a recording using a D-Net device. Retry after connecting a recordable device (DVHS, AVHDD).
"Not available while recording" message appears	The message appears informing you that you cannot change the channels or change the input source using the remote control because a recording is in progress through D-Net. Retry after stopping the current recording through D-Net.
"The connected device is unavailable to perform this function for temporary problems." message appears.	This message appears when the selected function is not supported by the relevant device or the relevant device cannot execute the selected function. Most STBs, DTVs and camcorders do not support the power on/off command. This message may appear when you issue the power command for these devices. This message also appears when the command is supported but the relevant device cannot follow the command. Retry after checking the current mode of the relevant device.
D-Net cannot record video from analog channels from connected external equipment.	This message appears when the user presses the RECORD button in analog mode. D-Net only supports recording for digital.
"Not available format is selected." message appears.	This message appears when the selected device does not support the MPEG format. At present, D-Net supports MPEG TS only.

Continued...

Using the D-Net

Problem	Possible Solution
This device is unavailable for D-Net.	This message appears if you have connected a 1394 device or equipment other than a supported device (DVHS, DTV, STB, AVHDD, Camcorder), or if the connected device does not support the AVC defined in the 1394 specifications, even if the device is a supported device, when you have selected the device to use it.
Connection failed. Check if the 1394 cable is connected.	This message appears if there is a connection problem when trying to use a D-Net device.
Initializing...	This message appears if the AVHDD is booting when trying to use the AVHDD.
Please wait. A recordable device is on standby.	This message appears if the recording device is turned off when trying to record using the D-Net device. Please wait a moment until it is turned on.
Connection failed. The device is not responding.	This message appears if there is a connection problem when trying to use a D-Net device. This message appears when the response of the component device malfunctions or is incorrect.
No space left on disc.	This message appears if the AVHDD has no space to record.
The D-NET ERROR message appears on the screen.	Although you have connected external devices according to the procedures described in the manual to use the D-Net function, the D-NET ERROR message may appear on the screen. In this case, check to see if the jacks are damaged.



PC Display



PC Display

Using Your TV as a Computer (PC) Display

How to Connect Your PC to the TV

This figure shows the Standard Connector-jack panel. The actual configuration on your TV may be different, depending on the model.

Connecting a PC (15p D-SUB) to the TV

- 1 Connect a PC cable between the PC Output jack on the PC and the RGB input jack (PC IN) on the TV.
- 2 Connect a Audio cable between the Audio jack on the PC and the Audio input jacks (PC AUDIO IN) on the TV.

TV Rear Panel

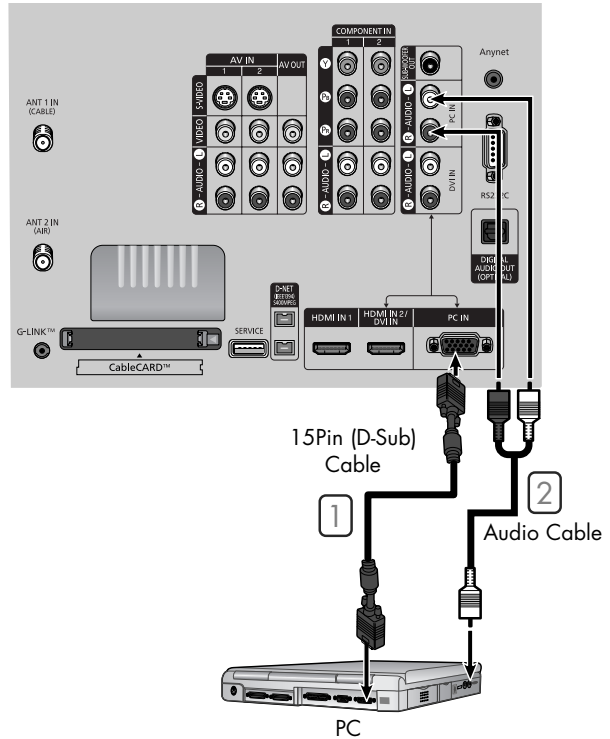

Setting up Your PC Software (Windows only)

The Windows display-settings for a typical computer are shown below. But the actual screens on your PC will probably be different, depending upon your particular version of Windows and your particular video card. But even if your actual screens look different, the same, basic set-up information will apply in almost all cases. (If not, contact your computer manufacturer or Samsung Dealer.)

1. Right click the mouse on the Windows Desktop, then click on Properties. The Display Dialog-Box will be displayed.
2. Click on Settings, then set the Display Mode with reference to the Display Modes Table. You do not need to change the Colors settings.
3. Click on Advanced. A new settings dialog box will be displayed.
4. Click on the Monitor tab, then set the Screen Refresh Rate with reference to the Display Modes Table. Set the Vertical Frequency and Horizontal Frequency individually if you can do so, instead of setting the Screen Refresh Rate.
5. Press the OK button, close the window, then press the OK button on the Display Registration Information window. Automatic re-booting may commence at this moment.
6. Shutdown the PC, and connect it to your TV.
 - * The actual screens on your PC may look different, depending on your particular version of Windows and the type of your PC.
 - * When you use your TV as a PC monitor, it supports Colors up to 32 bits.
 - * In this case, the display on the TV may look different depending on your particular version of Windows or the PC manufacturer.
 - * When connecting a PC, you must set it to the display settings that are supported by the TV. Otherwise, the message Out of input range will be displayed.

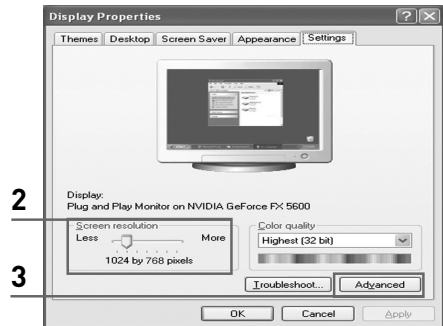

2

3



4

5

continued...

PC Display

Checklist Before Connecting to a PC

- Adjust the PC Display Setup to the resolution and frequency values that are supported by the TV.
- Please read the user's manual provided with the PC (Graphic Card & Sound Card).
- Do not supply power to either device until all connections are complete.
Supplying power in the middle of connecting may cause damage to the product.
- Check the terminal types for the PC's graphic card.

Setting the Display Modes to be Compatible with Your TV

Mode	Resolution	Vertical Frequency [Hz]	Horizontal Frequency [KHz]	Vertical Polarity	Horizontal Polarity
IBM	640 x 350	70.086	31.469	N	P
	720 x 400	70.087	31.469	P	N
VESA	640 x 480	59.940	31.469	N	N
		72.809	37.861	N	N
	800 x 600	75.000	37.500	N	N
		56.250	35.156	P/N	P/N
		60.317	37.897	P	P
		72.188	48.077	P	P
	1024 x 768	75.000	46.875	P	P
		60.004	48.363	N	N
		70.069	56.476	N	N
	1280 x 1024	75.029	60.023	P	P
		60.020	63.981	P	P
	1920 x 1080	75.025	79.976	P	P
		59.988	66.647	N	P

NOTES

- The Modes Table conforms to the regulations of IBM/VESA and is prepared based on analog input standards.
- The optimal resolution is 1920 x 1080 @ 60Hz.
- The optimal timing per each mode is the Vertical Frequency 60Hz.
- Resolutions other than the resolutions above are not supported in PC mode.
- Although the OSD menu may shake when selecting a PC input of 1920 x 1080, this is not a defect. Therefore, please use the unit as usual.

Adjusting the Picture Quality

The purpose of picture quality adjustment is to remove or reduce picture noise. If the noise is not removed by fine tuning alone, then do the frequency adjustments to the utmost and fine tune again. After the noise has been reduced, re-adjust the picture so that it is aligned on the center of screen.



NOTE

- This feature may change the width of the image. If necessary, adjust the position to center.

1 Press the SOURCE button to select "PC".

2 Press the MENU button. Press the ▲ or ▼ button to select "Setup", then press the ENTER button.

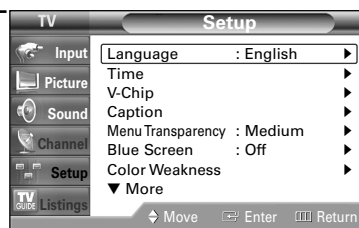

3 Press the ▲ or ▼ button to select "PC", then press the ENTER button.

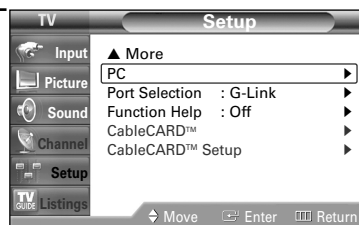

4 Press the ENTER button to select "Image Lock", then press the ENTER button.

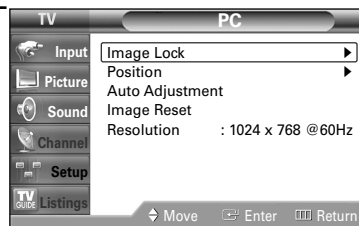

5 Press the ▲ or ▼ button to select "Coarse" or "Fine", then press the ENTER button.

- You can also select these options (Coarse, or Fine) by pressing the ▲ or ▼ button.

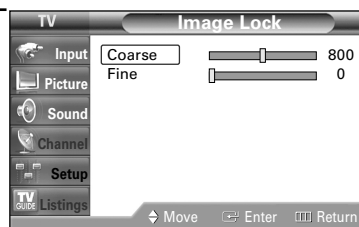

6 Pressing the ◀ or ▶ button to remove the picture noise.

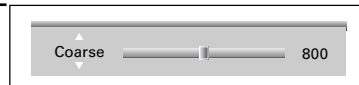

Press the EXIT button to exit.

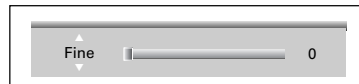

Changing the Picture Position

After connecting the TV to your PC, adjust the position of picture if it is not well-aligned.



1 Press the SOURCE button to select "PC".

2 Press the MENU button. Press the ▲ or ▼ button to select "Setup", then press the ENTER button.

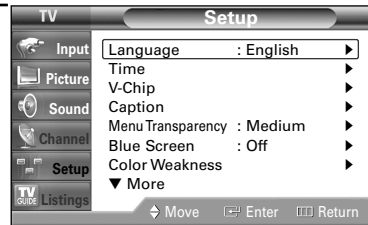

3 Press the ▲ or ▼ button to select "PC", then press the ENTER button.

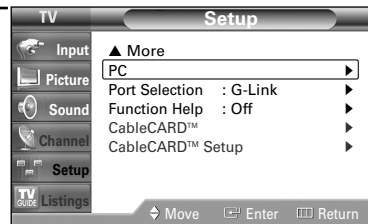

4 Press the ▲ or ▼ button to select "Position", then press the ENTER button.

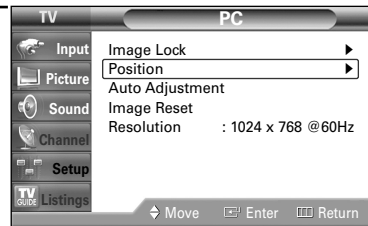

5 Adjust the position of picture by pressing the ▲/▼/◀/▶ button.

Press the EXIT button to exit.

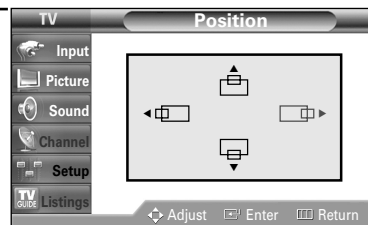

Adjusting the Picture Quality and Position Automatically

This feature allows the TV to self-adjust to the incoming video signal. The values of fine, coarse and position are adjusted automatically.



1 Press the SOURCE button to select "PC".

2 Press the MENU button. Press the ▲ or ▼ button to select "Setup", then press the ENTER button.

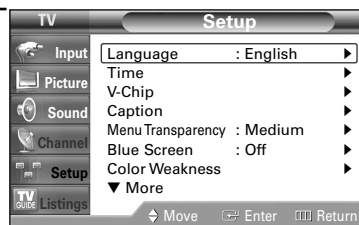

3 Press the ▲ or ▼ button to select "PC", then press the ENTER button.

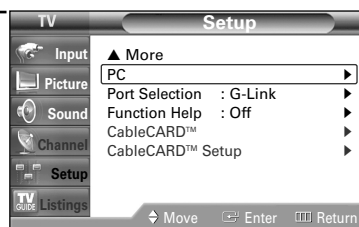

4 Press the ▲ or ▼ button to select "Auto Adjustment", then press the ENTER button. The picture quality and position are automatically adjusted, and the picture returns to original view about a few seconds later.

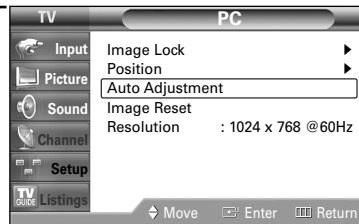

Press the EXIT button to exit.

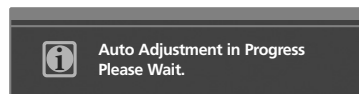

Changing the Picture Size (PC Mode)

You can select the picture size which best corresponds to your viewing requirements.



1 Press the SOURCE button to select "PC".

2 Press the MENU button.
Press the ▲ or ▼ button to select "Picture", then press the ENTER button.
Press the ▲ or ▼ button to select "Size", then press the ENTER button.

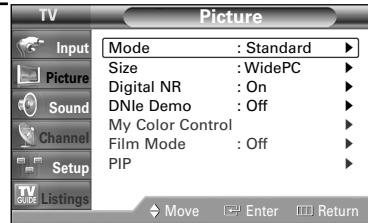

3 Press the ◀ or ▶ button to select the screen format you want, then press the ENTER button.

Press the EXIT button to exit.

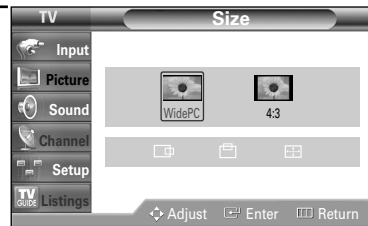

NOTES

- "4:3": Displays the picture as it is without changing the aspect ratio of input source.
- "WidePC": Scales the picture to 92% of the TV screen, regardless of the aspect ratio of the input source. The picture position (◻, ◻) and size (◻) adjustment are available by pressing the ▲/▼/◀/▶ button.

Alternate method

Press the P.SIZE button on the remote control repeatedly to change the picture Size.

Viewing the Current Resolution

You can get the resolution information of your PC.

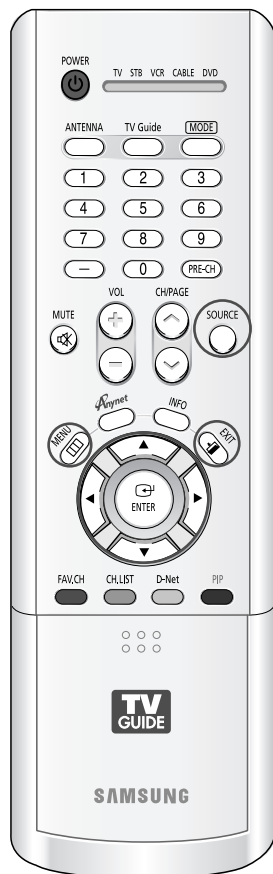

1 Press the SOURCE button to select "PC".

2 Press the MENU button. Press the ▲ or ▼ button to select "Setup", then press the ENTER button.

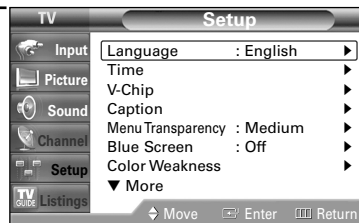

3 Press the ▲ or ▼ button to select "PC", then press the ENTER button.

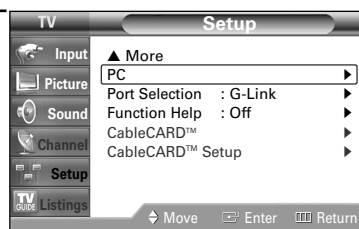

The resolution information is displayed on the screen.

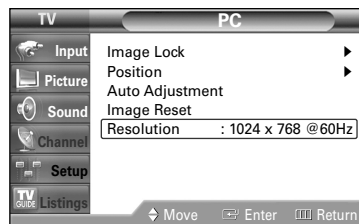

NOTE

- To change the resolution, see pages 129~130.

PC Display

Initializing the Picture Settings

You can replace all picture settings with the factory default values.



1 Press the SOURCE button to select "PC".

2 Press the MENU button. Press the ▲ or ▼ button to select "Setup", then press the ENTER button.

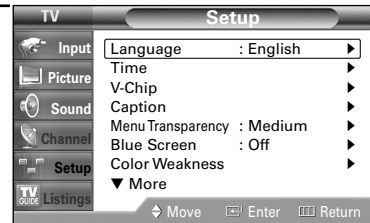

3 Press the ▲ or ▼ button to select "PC", then press the ENTER button.

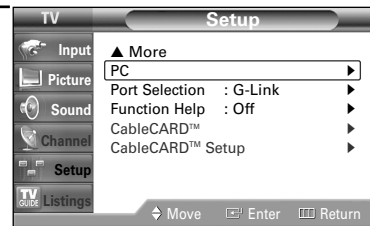

4 Press the ▲ or ▼ button to select "Image Reset", then press the ENTER button. The picture settings are replaced with the factory default values.

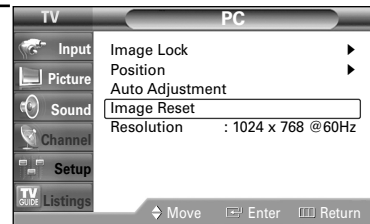

Press the EXIT button to exit.

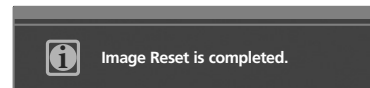

A horizontal bar with a white left section and a grey right section. The word "Appendix" is centered in the white section. A thin black line extends from the top of the white section upwards and to the left.

Appendix

Replacing the Lamp

- **Why do I need to replace the lamp?**

The lamp used in a DLP TV has a limited lifespan. For the best screen quality it needs to be replaced periodically. After replacing the lamp, the screen quality will be bright and clear as new.

- **When do I need to replace it?**

It should be replaced when the screen becomes darker, less clear or when all three LEDs on the front (TIMER, LAMP, & STAND BY/TEMP) are flashing.

- **Check before lamp replacement**

1. The lamp must be the same code number and type.
2. The lamp type is indicated on the side of the TV. It is also indicated on the lamp case.
3. After checking the code number for the lamp, give the code number to the store where you purchased the TV or to a Samsung Service center.

- **Caution**

1. Replace with the correct code numbered lamp to avoid damage to the TV.
2. Turn the power off and wait for 30 minutes before replacing the lamp as it will be hot.
3. Do not touch the glass part of the lamp with your bare hands and do not insert any foreign object inside the cover as it may cause poor screen quality, electric shock or fire.
4. Do not place the old lamp near flammable objects or within the reach of children.
5. Be sure to connect this TV directly to an AC wall outlet. If the TV's AC plug is connected to a cable box or other source, it will not allow for proper cool down time.

- For replacement, you will need a 5.91-Inch screwdriver and a pair of gloves.

1 Unplug TV, then use a screwdriver to remove the screws.



2 Remove the Lamp cover.



3 Remove the screw securing the Lamp by using a screwdriver.



4 Separate the Lamp from the engine by holding the handle and pulling it out.



5 To reinstall the Lamp, follow these steps in reverse order.

NOTES

- Be sure the replacement Lamp is the same type.
- After replacing the lamp, align the lamp cover with the groove and secure the screws.
- The TV will not turn on if the lamp cover is not correctly closed (as this will activate the protective circuit).

Appendix

Troubleshooting

If the TV seems to have a problem, first try this list of possible problems and solutions. If none of these troubleshooting tips apply, then call your nearest Samsung authorized service center.

Problem	Possible Solution
Poor picture quality.	Try another channel. Adjust the antenna. Check all wire connections.
Poor sound quality.	Try another channel. Adjust the antenna.
No picture or sound.	Try another channel. Press the SOURCE button. Make sure the TV is plugged in. Check the antenna connections. Check that the Mute feature is off.
No color, wrong colors or tints.	Make sure the program is broadcast in color. Adjust the picture settings.
Picture rolls vertically.	Adjust the antenna. Check all wire connections. If you are using a VCR, check the tracking.
The TV operates erratically.	Unplug the TV for 30 seconds, then try operating it again.
Your remote control does not operate your TV.	Press the MODE button to put your remote control into TV mode. Make sure the remote has batteries.
The TV won't switch on.	Make sure the wall outlet is working. Make sure the TV is plugged in. Make sure the remote has batteries.
Digital broadcasting screen problem.	Please check the digital signal strength and input antenna.
There is a "clicking" sound repeatedly in Standby mode.	There is a sound when both Air and Cable are set to "Yes" in the TV Guide On Screen™ Setup. The sound is made by the TV trying to receive TV Guide On Screen™ data in Standby mode, and is not a defect. Set up the Antenna (Air)/Cable according to the connection status in the TV Guide On Screen™ Setup.

Continued...

Problem	Possible Solution
<p>The visual quality of 1080p will appear the same as for other DTV resolutions.</p>	<p>This TV receives a signal input and converts the signal into 1080p through signal processing. Although the resolution of this TV is 1920 x 1080, to watch TV with a higher visual quality and sharpness than a conventional TV, you can watch TV in a better visual quality when the input signal resolution is 1080p.</p>
<p>I want to view the clearest picture on the TV in 1080p resolution.</p>	<p>The best visual quality is supported for 1080p input signal. → To view TV in the best visual quality of 1080p, connect to a PC whose graphic output is WUXGA (1920 x 1080).</p>
<p>The visual qualities of digital channels vary.</p>	<p>The visual qualities of digital channels may vary depending on the original production method (analog or digital). → Classification by the information displayed when switching channels. → If the original production method is digital: High visual quality program. → If the original production method is analog: The digital program displayed on the screen is originally an analog program which has been converted. The visual quality is of an SD grade.</p>
<p>Although the TV caption shows HD, the visual quality is not satisfactory.</p>	<p>The HD caption that appears when switching channels or when pressing the Information button on the remote control means the selected channel is simply a digital channel. If the broadcasting station converts an analog signal into digital and transmits the signal, the visual quality may not be perfect. (Appplied to Set Top Box built-in model only.)</p>

- The display panel used for the DLP TV is composed of many tiny pixels. These pixels may occasionally appear on the screen.

Cleaning and Maintaining Your TV

With proper care, your TV will give you many years of service. Please follow these guidelines to get the maximum performance from your TV.

Placement

- Do not put the TV near extremely hot, cold, humid or dusty places.
- Do not place the TV near appliances with electric motors that create magnetic fields, such as vacuum cleaners.
- Keep the ventilation openings clear; do not place the TV on a soft surface, such as cloth or paper.
- Place the TV in a vertical position only.

Liquids

- Do not handle liquids near or on the TV. Liquids that spill into it can cause serious damage.

Cabinet

- Never open the cabinet or touch the parts inside.
- Wipe your TV with a clean, dry cloth. Never use water, cleaning fluids, wax, or chemicals.
- Do not put heavy objects on top of the cabinet.
- This DLP TV projects the image onto a large screen by applying an optical system. If you place the TV set face down, it might cause a problem because dirt, or some other contaminant may become attached to the inside of the TV set.

Temperature

- If your TV is suddenly moved from a cold to a warm place, unplug the power cord, and allow at least two hours for moisture that may have formed inside the unit to dry completely.

Using Your TV in Another Country

If you plan to take your TV with you to a foreign country, please be aware of the different television systems that are in use around the world. A TV designed for one system may not work properly with another system due to differences in the TV channel frequencies.

Specifications

Model	HLR5078W	HLR5678W	HLR6178W	HLR7178W
Voltage	AC 110 - 120V~	AC 110 - 120V~	AC 110 - 120V~	AC 110 - 120V~
Frequency of Operation	60Hz	60Hz	60Hz	60Hz
Power Consumption	230 watts	230 watts	230 watts	230 watts
Dimensions (W x D x H)	46.54 x 13.98 x 34.24 inches 1182 x 355 x 869.7 mm	52.36 x 15.30 x 37.86 inches 1330 x 388.5 x 961.7 mm	56.93 x 18.37 x 41.59 inches 1446 x 466.5 x 1056.5 mm	65.79 x 20.43 x 46.81 inches 1671 x 519 x 1189 mm
Weight	34.3 Kg / 75.62 lbs	38.5 Kg / 84.77 lbs	45 Kg / 99.21 lbs	52.9 Kg / 116.6 lbs



ELECTRONICS

1-800-SAMSUNG (1-800-726-7864)

**Samsung Electronics America
Service Division**

400 Valley Road, Suite 201
Mount Arlington, NJ 07856
www.samsung.com

**Samsung Electronics Canada Inc.
Samsung Customer Care**

55 Standish Court
Mississauga, Ontario
L5R 4B2
www.samsung.ca